

EASYGUARD



User Manual of EC002

► Contact us

Zhongshan Easyguard Electronics Co.,ltd

Add: 2nd floor, building 3, No 77 caihong Road, West district,
Zhongshan city, Guangdong, China

Phone: 86-760-22113597

Web: www.ieasyguard.com

Email: sales@ieasyguard.com

Important: This device can improve the vehicle safety level, but could not prevent the vehicle from stolen or the occurrence of unexpected accidents. EASYGUARD Electronics will not be liable for any resulting from the damage of this product cause by direct or indirect losses.



INDEX

Safety warning	1
Installation guide	
1.Before starting the installation	2-3
2.DIP switch setting on control module	3
3.Deciding on components locations	4
Antenna & touch password keypad introduction	4-8
Main wire harness introduction & note 1-18	8-14
Engine start button introduction	14-17
Key FOB buttons introduction & function description	17-19
Manual for releasing the steering lock	20-21
Installation for chip immobilizer	21-22
Programming method	22
Central door locking wire connection	23-30
Wiring diagram of Easyguard EC002	31-32

Function description

1.Push button start/stop	33-34
2.PKE-passive keyless entry	34
3.Manual arm/lock	34
4.Manual disarm/unlock	34
5.Mute alarm & audible alarm	34
6.Remote trunk release	34
7.Panic mode/Car finding	34
8.To enable or disable PKE feature(PKE on/off setting)	35
9.Remote engine start/stop	35-36
10.Dome light supervision (optional)	36
11.Anti-hijacking	37
12.Alarm trigger by illegal door opening	37
13.Central door locking automation	37
14.Touch password entry	37-40
15.Power off memory	40
16.Door unlock well warning	40
17.Alarm reminder	40
18.Door opening while driving warning	40
19.ACC ON warning	40
20.Emergency override	40
21.Power saving & car battery low power protection	40
22Automatic window closing (optional)	40
23.Vibration alarm (optional)	41
24.GPS tracker (optional)	41
25.Parameter time prolong setting	41-42
Technical parameter	42
FAQS of EC002	43-44

Dear Customer,

Thank you for purchasing our EASYGUARD EC002 series PKE car alarm with push start stop button. This alarm is combine with latest PKE (passive keyless entry) technology, remote engine start, keyless go and touch password entry backup function. Please read the user manual and wire diagram carefully before you start installation. Once the alarm is properly installed, it can improve the safety of your vehicle greatly.

This product can work with fuel-injected, automatic transmission, or vehicles with manual transmissions DC12V vehicles.

IMPORTANT:

This product is intended to be installed by a professional car alarm installer only! Any attempt to install this product by any person but not a trained professional car alarm installer may result in severe damage to the vehicle or the components.

If user want to do the DIY installation, please study all the user manual and wiring diagram carefully before you start installation and only make sure you understand everything then start the installation. You may need to search on the internet for your vehicle wiring diagram if necessary, and learn how to find the related wires and how to connect them properly.

Once you find correct wires, please solder them well or use crimp connectors to connect the wires well when finished the wire connection to avoid any loose up when the vehicle running and cause the device failed to work. If there is any questions, please contact EASYGUARD authorized dealer or contact EASYGARD electronics directly for help.

Safety warning!

The following safety warnings must be observed at all the time:

Due to the complexity of this system, installation of this product must be finished by a professional car alarm installer or trained alarm installer.

Once the product is properly installed, this system can remote start the vehicle by a command signal from the remote control Therefore, never operate the system in an area that does not have adequate ventilation. The following precautions are the sole responsibility of the user; however, authorized EASYGUARD Electronics dealers should make the following recommendations to all users of this system:

- 1.Never operate the system in an enclosed or partially enclosed area without ventilation (like a garage).
2. When parking in an enclosed or partially enclosed area or when having the vehicle serviced, please do not use the remote engine start feature.
- 3.It is the user's sole responsibility to properly handle and keep out of reach from children all remote controls and other accessories in the kit to assure that the system does not remote start the vehicle occasionally.

USER MUST INSTALL A CARBON MONOXIDE DETECTOR IN OR ABOUT THE LIVING AREA ADJACENT TO THE VEHICLE . ALL DOORS LEADING FROM ADJACENT LIVING AREAS TO THE ENCLOSED OR PARTIALLY ENCLOSED VEHICLE STORAGE AREA MUST REMAIN CLOSED AT ALL THE TIMES.

Use of this product in a manner contrary to its intended mode of operation may result in property damage, personal injury, or death. Except when performing the safety checking indicated in this installation guide.

(1) Never remote start the vehicle with the vehicle in gear, and.

(2) Never remote start the vehicle with the keys in the ignition. If the vehicle starts in gear, cease remote start operation immediately and consult with the user to fix the problem immediately.

(3). When use remote engine start function, the gear selector should in Neutral (N) position. If your vehicle is manual transmission, please refer to remote engine start for manual gear car.

Remote starters for manual transmission pose significant risks if not properly installed and operated. When testing to ensure the installation is working properly, only remote start the vehicle in neutral gear, on a flat surface and with a functional, fully engaged parking brake. Do not allow anyone to stand in front of or behind the vehicle.

This product should NOT be installed in any convertible vehicles, soft or hard top. Installation in such vehicles may pose certain risk.

Installation Guide

1.Before Starting the Installation

Please read all the installation guide before starting the installation. The installation of this PKE car alarm with remote start system requires interfacing with many of the vehicle's systems. Many new vehicles use low-voltage or multiplexed systems that can be damaged by low resistance testing devices, such as test lights and logic probes (computer safe test lights). Test all circuits with a high quality digital multi-meter before making connections.

Do not disconnect the battery if the vehicle has an anti-theft-coded radio. If equipped with an air bag, avoid disconnecting the battery if possible. Many airbag systems will display a diagnostic code through their warning lights after they lose power. Disconnecting the battery requires this code to be erased, which can require a trip to the car dealer.

To avoid accidental battery drainage, turn off the interior lights or remove the dome light fuse.

Roll down a window to avoid being locked out of the car.

1.Check the packing list:

Full set device should include following components:

Control module x1

Key fob x2

Push start button x1

Alarm high frequency antenna: x1(with red color connector)

PKE antenna: x2

Touch password keypad: x1

6P ignition wire harness: x1

20P wire harness: x1

3 color (orange, white, yellow) GWR wire x1 or (shock sensor x1)

Note: if the device equip with 3 color (orange, white, yellow) GWR wire, then there is no shock sensor in the kit, vice versa.

English user manual & wiring diagram x1

Important:

Only start installation when you receive all the accessories.

If there is missing any parts, please stop installation immediately and contact your vendor right away for the replacement.

2. DIP Switch Setting on Control Module

Please set the DIP switch on the control module to fit for your vehicle. See DIP switch as below picture:

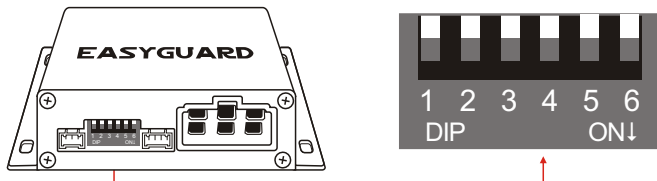

There are 6 DIP switches on the control module and each DIP switch function as below:

Switch 1: When press up is with locking output pulse signal once, when press down is with locking output pulse signal twice. If your central door require once pulse locking signal, please press it up; if your central door require twice locking pulse signal, please press it down.

Switch 2: When press up is turn off time delay of the door, When press down is turn on time delay of the door .

Switch 3: When press up is with unlock output pulse signal once, when press down is with unlocking output pulse signal twice. If your central door require once unlocking pulse signal, please press it up; if your central door require twice unlocking pulse signal, please press it down.

Switch 4: When press up is turn off anti-hijacking function and when press down is turn on anti-hijacking function. Default is turn on the anti-hijacking function.

Switch 5: When press up is for manual transmission car and when press down is for automatic transmission car. If your car is manual transmission, please press this switch up; if your car is automatic transmission car, please press down this switch.

Switch 6: When press up is for turn off return current and when press down is turn on return current

Notes: For Switch 6 default is press up. For some vehicles, need to turn the key to ON position first then the foot brake is with electricity when stepping on it. For such kind of vehicles, need to press down switch 6. The switch 6 press down is mainly for some Volkswagen cars usage.

IMPORTANT:

- 1.We recommend you to set the DIP switch before you making wire connection.
- 2.If the alarm control module already connect with 6 pin wire harness and you want to re-set the DIP switches, please follow with below instructions:
 - a.Un-plug the 6 pin ignition wire harness to cut off power of the device
 - b.Press down or up the DIP switch you want to re-set
 - c.Re-plug the 6 pin ignition wire harness to re-power the device

3.Deciding on components locations

Control module

Some things to remember about where to mount the control module:

Never put the control module in the engine compartment!

The first step in hot-wiring a vehicle is removing the driver's side under-dash panel to access the starter and ignition wires. If the control module is placed just behind the driver's side dash it can easily be disconnected.

When mounting the control module, try to find a secure location that will not require you to extend the harnesses' wires. Keep it away from the heater core (or any other heat sources) and any obvious leaks.

Some good control module locations are: Above the glove box, inside the center console, above the under-dash fuse box, or above the radio.

Antenna & touch password keypad introduction

There are 3 antennas in the kit. Among them, one is alarm high frequency antennas and 2 are PKE antennas. Here are some information of them respectively:

Name	Connector size & color	Wire length (in)	Recommend mount position
High frequency antenna	Red, 3pin	47.24	P1(A pillar near the cab) or P2(under the steering wheel) position
PKE antenna (2.9m)	Black,3 pin	114.17	Inside upper middle front windshield(P3 position)
PKE antenna(5.0 m)	Black, 3pin	196.85	Inside upper left of rear windshield(P4 position)
Touch password key pad	Black, 4pin	78.74	Inside of front windshield (P5 position)

High frequency antenna:

The high frequency antenna is with red color connector (3pin)

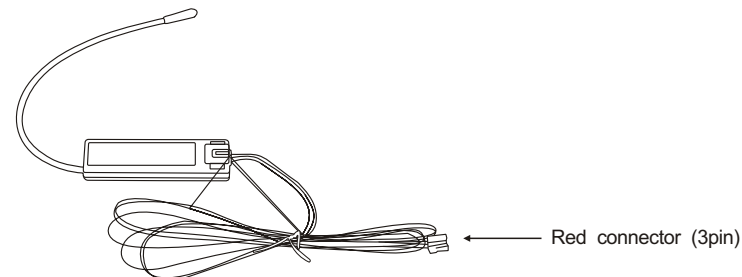

PKE antenna

There are 2 PKE antennas

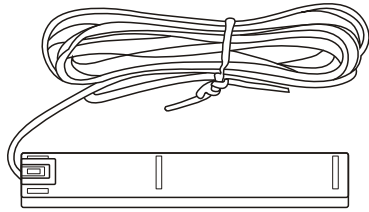

2.9M PKE antenna

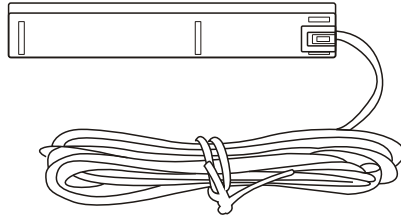

5M PKE antenna

Warning:

All the antennas are fragile and easy to break, please handle with care when mount them or plug/unplug them. Please do not pull the antenna to avoid the wires break off.

Here is the recommendation mount position for each of them:

Never mount the PKE antennas on any metallic surface as this will decrease the PKE induction range obviously

In order to have a stable PKE induction range, secure the PKE antenna & make sure they will not move or dangle

The PKE antennas are fragile & easy to break, please handle with care when mounting them or plug/unplug them when installation. Please also make sure they are mounted on a solid (non-flexible) surface.

Recommended PKE antenna mount position

The recommended PKE antenna mount position is for reference only. And we'd like to recommend you to adjust the PKE antenna mount position to get a maximum PKE induction range.

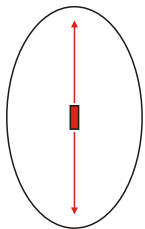

Vertical range

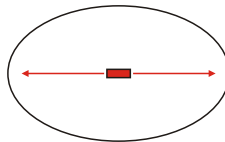

Horizontal range

As the PKE antenna is a directional antenna, the PKE induction range will be affected by the antenna placement/mounting position.

PKE antenna mount position

Position B is the most common and widely used one.

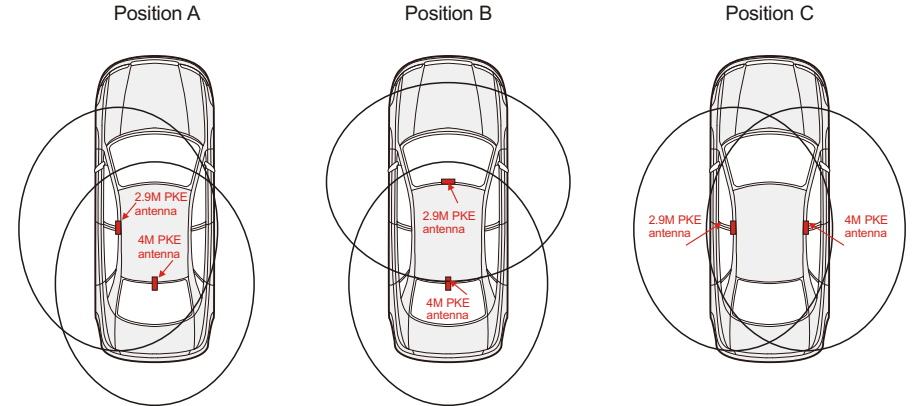

Some suggestions about the PKE antenna mount position for different vehicles:

For sub compact, compact & sedan:

For optimal performance, mount the 5M PKE antenna in the headliner or below the rear deck.

IMPORTANT:

Mount the PKE antenna in the trunk will greatly affect and reduce the PKE induction range and overall system working performance.

Pickup (with cab) & cargo:

Mount the 5M PKE antenna in the bumper, behind the license plate.

Pickup (without cab):

Recommend the PKE antenna on position C. the PKE antennas should be mounted on the driver and passenger side as the tailgate does not require to be controlled.

Convertible:

Mount the 2.9M PKE antenna in front windshield pillar on driver side and the 5M PKE antenna behind the rear seats.

Note: On vehicle with fiberglass bodies or convertibles, the PKE induction range will be increased.

P5: The touch password keypad mount position
P5: Inside of front windshield in the car



Once finish mount the PKE antenna, the front PKE antenna and the rear PKE antenna looks like "T" shape

P3: The shorter PKE antenna mount position
P3: Inside of middle upper of the front windshield in the car



P4: The 5M PKE antenna mount position
P4: Inside of the left upper of the rear windshield in the car

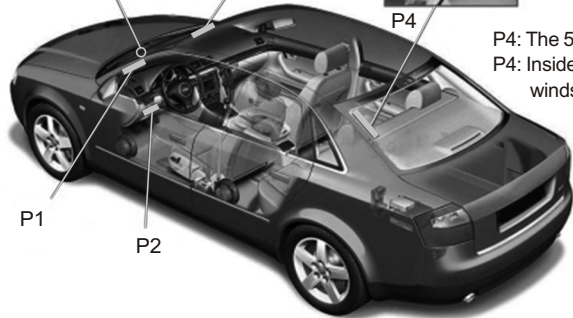

P1 or P2: High frequency antenna mount position.

P1: A pillar near the cab in the car

P2: Under the steering wheel

User can choose to mount the high frequency antenna on P1 or P2 position.

Important:

All the recommend mount position is for reference only and user can adjust the mount position to get a maximum antenna working range

Try your best to keep all the antennas away from any metal product.

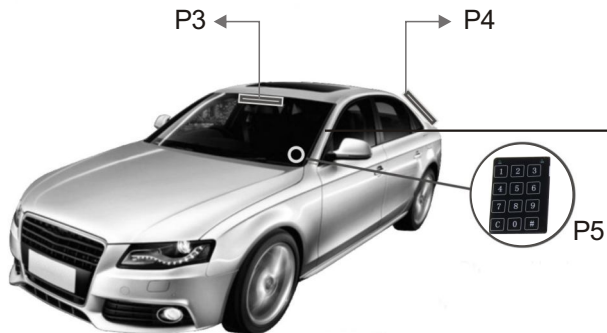

P1: A pillar near the cab in the car

Installation for password keypad

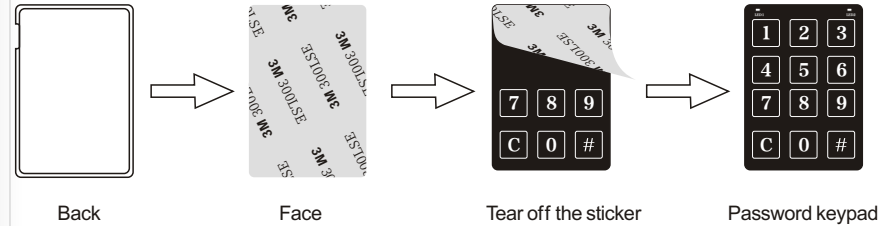

How to mount the touch password keypad?

1. Tear off the sticker on the password keypad
2. Stick the touch password keypad on the left bottom of inside of front windshield(the position should be easily & convenient for you to input the password)
3. Make sure there is no explosion proof film on the area where you plan to mount the touch password keypad

NOTE:

If you do not want to use touch password keypad entry function, no need to install/mount the touch password keypad.

P5: The touch password keypad mount position

P5: Inside of front windshield

Making Your Wiring Connections

Before making your connections, plan how your wires will be routed through the vehicle. For instance, the red 12V constant input and the remote start ignition wires will often be routed together to the ignition switch harness. In order to keep the wiring neat and make it harder to find, you may wish to wrap these wires together in electrical tape or conceal them in tubing similar to what the manufacturer used.

There are two acceptable ways of making a wire connection - solder connections and crimp connectors. When properly performed, either type of connection is reliable and trouble-free. Regardless of whether you solder your connections or you use mechanical type crimp connections, ensure that all connections are mechanically sound and that they are insulated.

Cheap electrical tape, especially when poorly applied, is not a reliable insulator. It often falls off in hot weather. Use good-quality electrical tape or heat shrink.

Never twist-and-tape the wires together without soldering.

Never use "fuse taps", as they can damage fuse box terminals.

Main wire harness introduction

1.6-Pin ignition wire harness

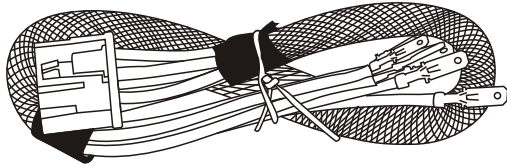

Wire colors	Wire usage	Remark
Orange	Connect with Accessory(ACC)	See note 5,7
White	Connect with ignition 1 wire	See note 2,4
Brown	Connect with ignition 2 wire	See note 3,4
Red	Connect with constant +12V	See note 1
Red	Connect with constant +12V	See note 1
Yellow	Connect with starter wire	See note 6

NOTE (1-7):

- 1.If there is only one +12V wire in your vehicle ignition wire harness, then connect it with both +12V red wires in ec002;
 - 2.White ignition 1 wire: When turn the key to ON or ACC, this wire with electricity, when starting the car, this wire still with electricity;
 - 3.Brown ignition 2 wire: When turn the key to ON or ACC, this wire with electricity, when starting the car, this wire will cut off power suddenly at the moment of starting the vehicle;
- Once the vehicle is started, both white & brown wire are with electricity.
- 4.If there is only one ignition wire in your ignition wire harness, connect it with the white ignition 1 wire, no need to connect the brown ignition 2 wire
 - 5.If there are 2 ACC wire in your ignition harness, connect both ACC wires with orange wire in ec002.
 - 6.If there are 2 starter wires in your ignition harness, connect both starter wire with yellow wire in ec002.
 7. If your car is newer cars that no ACC(only ON & OFF), connect the orange ACC(Accessory) wire and white ignition 1 wire in EC002 wire harness with ignition 1 wire in your vehicle.

2.ABC 3 color GWR (ground while running) wire (see Note 8) or shock sensor (see note 9)

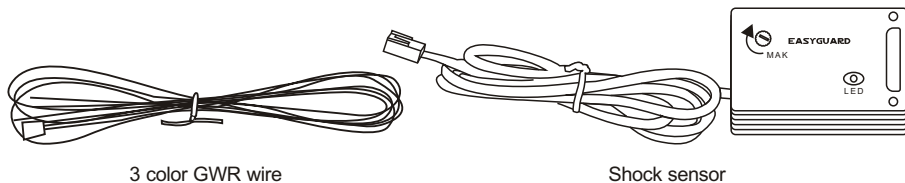

3 color GWR wire

Shock sensor

IMPORTANT:

If your kit is with 3 color GWR wire, then there is no shock sensor, vice versa.

Note 8:

If the alarm equip with 3 color GWR wire, which is used to connect with immobilizer bypass wire or GWR wire or status output wire

Connection method:

No need to connect orange wire for all below method:

Method 1: Cut off the car factory chip immobilizer wire into 2 parts, each end connect with the white & yellow wire respectively.

Method 2: if there is GWR(-) wire, connect the GWR(-) wire with white wire and connect yellow wire with chassis ground(GND)

Method 3: If there is key sense wire which require either ground(-) or positive(+) wire, connect the key sense wire with white wire and connect the yellow wire with chassis ground(-) or +12V respectively.

Note 9:

If the alarm is equip with shock sensor, then connect with shock sensor. If so, there will be no GWR wire in the kit and you can use the SPST relay to generate a GWR wire. Method is as below:

connect with GWR(-) from bypass module

Connect with
EC002 ACC or
ignition 1
(ACC is recommend)

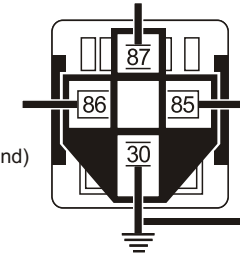

connect with chassis ground(GND)

You can also use a SPDT relay to generate a GWR wire and wiring method is the same but no need to connect 87a on SPDT relay.

3.20-Pin wire harness

Wire colors	Wire usage	Remark
The 1st row 10 pin wires		
Brown	Turn signal light/parking light(+)	
Brown	Turn signal light/parking light(+)	
Yellow/black	See central door locking installation	

White/black	Unlocking wire, see central door locking installation	15A
Orange/black	See central door locking installation	
Yellow	See central door locking installation	
White	Locking wire, see central door locking installation	15A, see note 16
Orange	See central door locking installation	
Pink	Output of factory horn(-)	-300mA, see note 17
Green wire	For GPS module, not used, insulate separately	
The 2nd row 10 pin wires		
Orange	Footbrake wire(+)	
Red	+12V wire for GPS module, not used, insulate separately	See note 10,18
Black	Chassis ground(-)	See note 15
Black	Chassis ground(-)	See note 15
White	For GPS module, not used, insulate separately	
Blue/black	Negative Door trigger input wire(-)	Can be changed to positive(+) by jumper, see note 10, 18
Blue	Fuel pump wire(+)	See note 11
Green/black	Trunk release	see note 13,14
Green	Output of trunk/trunk motor	see note 13,14
Purple	Trunk positive/negative selection wire	See note 12

Note 10

Wiring method for blue/black door trigger wire

The blue/black door trigger wire (-) default setting is negative (-) door trigger wire with jumper. See diagram as right:

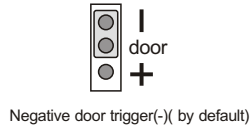

Door trigger jumper, default is negative(-)

If your car is with positive door trigger wire, please reset it with below instruction:

- Un-screw & open the alarm control module
 - Take out the jumper and reset it to be positive (+)
- see wiring diagram as right:

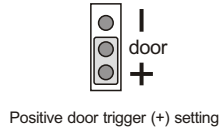

Once you re-set with the door trigger jumper to be positive (+), the blue/black door trigger wire is changed to be positive(+) now.

Note 11:

Wiring method for fuel pump wire

The Blue fuel pump wire is recommend to connect with fuel pump wire or oil pump wire/oil pressure wire or the sucker motor wire in your vehicle.

If you can't find those wires, please connect it with constant 12V wire or tach wire. This wire usage is to detect whether the car is started succeed or not & should be well connected.

Note 12:

Wiring method for purple trunk positive/negative selection wire

For the purple trunk positive/negative selection wire, if your trunk is positive trigger(+), please connect this wire with constant +12V wire; if your trunk is negative(-) trigger, this wire connect with chassis ground.

Note 13

Wiring method of negative (-) trigger of the trunk

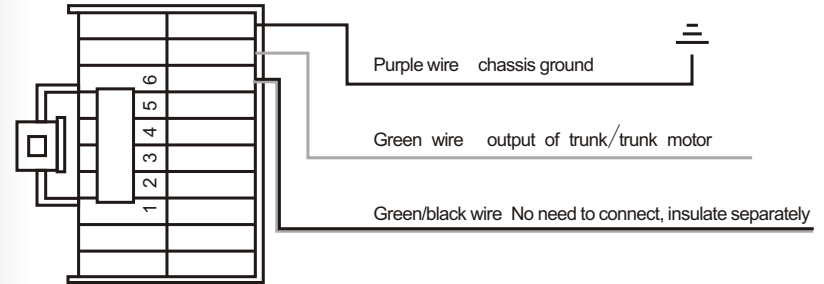

Note 14

Wiring method of Positive (+) trigger of the trunk

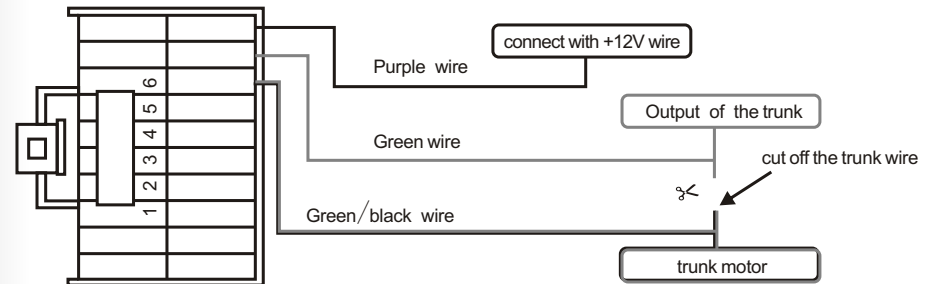

If the trunk is positive(+) trigger wire, need to cut off the trunk wire in half, the green wire is connect with the output of the trunk wire and the green/black wire is connecting with trunk motor wire respectively. Like 8th generation Accord of Honda, need to connect in this way.

Note 15

Wiring method of black chassis ground wire

We recommend that you do not use a factory ground. Ground all your components including the siren, to the same point in the vehicle, (preferably the kick panel). Scrape away any paint and use a factory bolt or make your own ground with a self-tapping screw and a star washer.

Please use a factory bolt or screw to attach all the black chassis ground wires securely as the photo show as below:

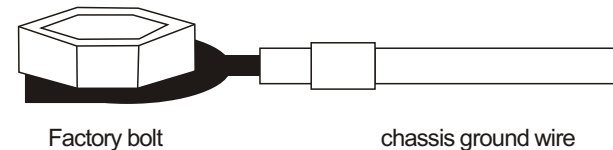

Note 16

Window closer module wire connection with Ec002

If there is window closer module has a wire need to connect with EC002, please connect the white locking wire in central door locking with the wire from the window closer module.

Note 17

Wiring method of horn or siren

The device default design is to connect with car factory horn with negative (-) 300mA output. If your vehicle factory horn is negative output, you can connect it with the pink wire of the device EC002 directly.

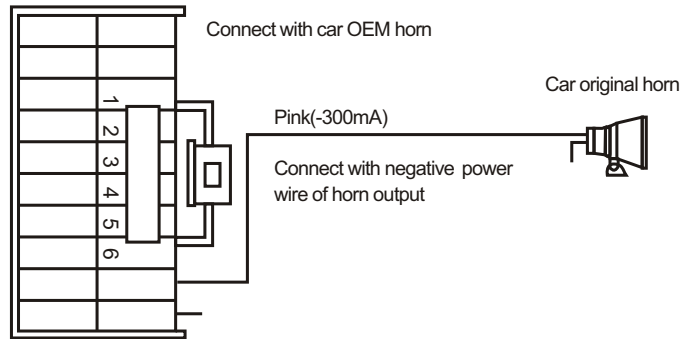

If your horn is positive output or you are connect with an electrical siren like 6 tone or 1 tone siren, please use a SPST relay to change the polarity first, here is the method:

Connect with horn or siren 12V+

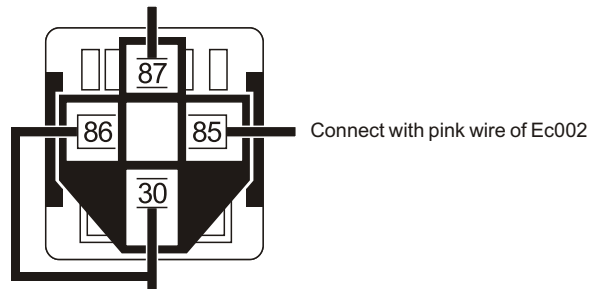

Connect with fused 12V+

Note: You can also use a SPDT relay to have a GWR wire and wiring method is the same but no need to connect 87a on SPDT relay.

Some things to remember about mounting the siren:

Keep it away from heat sources, such as radiators, exhaust manifolds, turbo-chargers, and heat shields.

Mount it where a thief cannot easily disconnect it, whether the hood is open or shut. Both the siren and its wires should be difficult to find. This usually involves disguising the wire to look like a factory harness.

We do not recommend grounding the siren to its mounting screws. Instead, we recommend running both the red and black wires into the passenger compartment and grounding to one common point for all devices. Both wires are the same length and come already bonded together to make it easier. Whenever possible, conceal your wires in the factory harnesses or in the same style loom as the factory.

When possible, place the siren on the same side of the vehicle as the control module, where its wires will reach the control module's wires without extending them. Always run the wires through the center of a grommet, never through bare metal!

When installation the siren, please make sure which is downward for waterproof consideration

Note 18

Dome light supervision (optional)

If there is dome light wire and you want to use dome light supervision, please follow with below instruction:

- No need to connect the blue/black door trigger wire in 20 pin wire harness
- Un-plug the 6 pin ignition wire harness to cut off power of the device first
- Press down DIP switch 2 on alarm control module & wait for around 5 minutes
- Re-plug 6 pin ignition wire harness to re-power of the device.

Then you should able to use dome light supervision function now.

Engine Start Button Introduction

There are 6 types engine start button available for optional as below:

The device default is equip with P1 style push start button, user can choose their preferred engine start button style.

P1 style engine start button

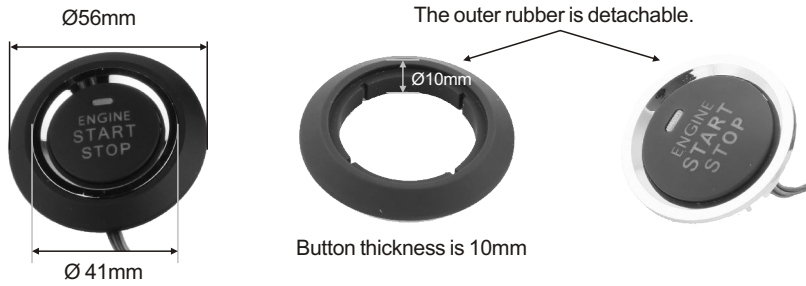

P1 button size: Ø56x10mm(with rubber), Ø41x10mm(no rubber),

P2 style engine start button

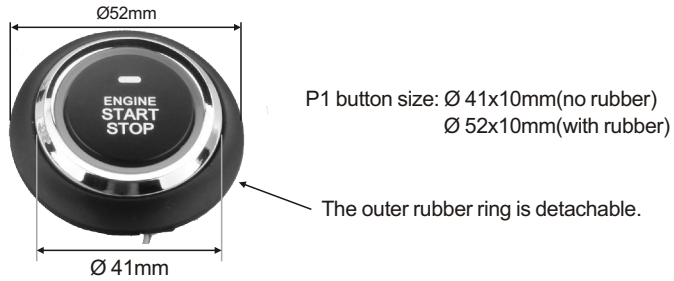

P3 style push start button



P4 style engine start button

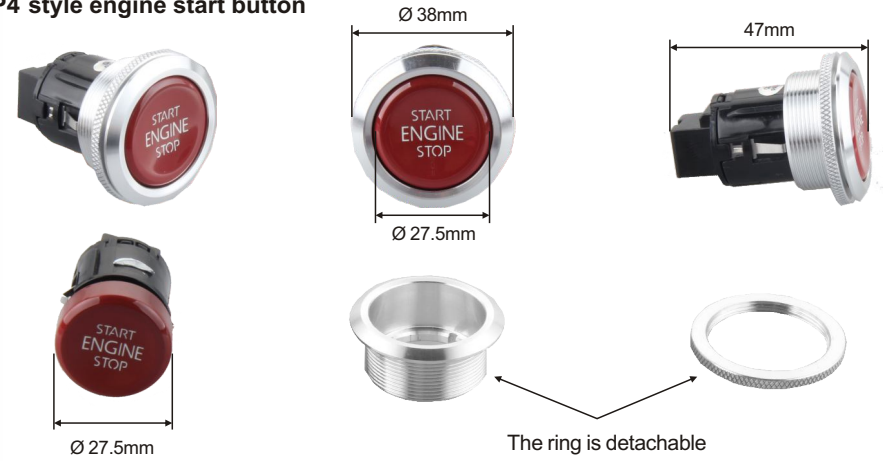

P5 style engine start button

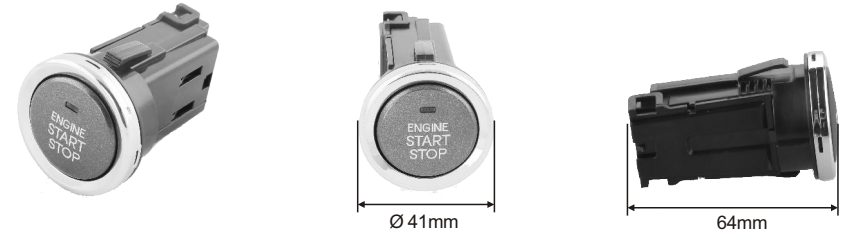



P7n style engine start button







Engine start button color changes for different operation

Engine start button style	When armed	When disarm	Turn on ACC	Turn on ON	Stepping On foot brake pedal	When started engine	When engine cut off & key in PKE range	When engine cut off & key out of PKE range	Button size(mm)
P1	Turn off	blue	blue	blue	Blinks blue color	green	blue	Turn off	Ø 41x10 (no rubber) Ø56x10 (with rubber)
P2	Turn off	blue	blue	blue	Blinks blue color	red	blue	Turn off	Ø 41x10 (no rubber) Ø52x10 (with rubber)
P3	Turn off	red	red	red	Blinks red color	red	red	Turn off	Ø27.5x47 (no ring) Ø38x47 (with ring)
P4	Turn off	red	red	red	Blinks red color	red	red	Turn off	Ø27.5x47 (no ring) Ø38x47 (with ring)
P5	Turn off	blue	blue	blue	Blinks blue color	Light red	blue	Turn off	Ø41x64
P7n	Turn off	red	red	red	Blinks red color	red	red	Turn off	Ø27.5x47 (no ring) Ø38x47 (with ring)

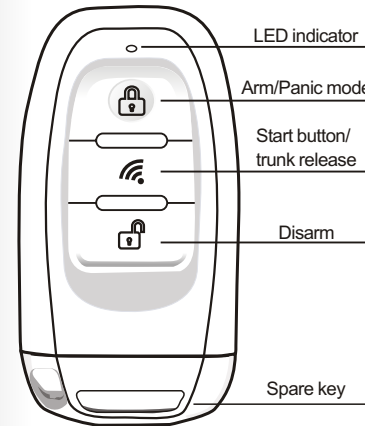

Key FOB Buttons Introduction & Function Description:

		
Arm/Panic mode	Disarm	Trunk release/start button

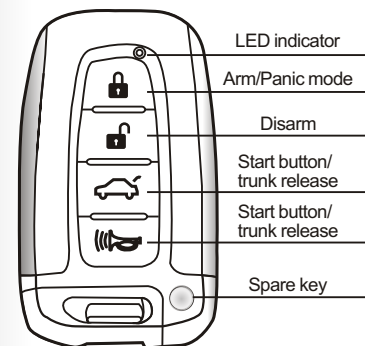
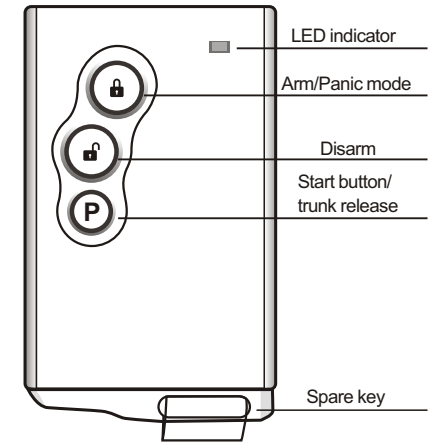

1. Lock/Arm: press lock button  once(turn off PKE function)
2. Unlock/disarm: press unlock button  once(turn on PKE function)
3. Remote engine start: In arm status, keep pressing the start button for around 3 seconds. Please keep at least 8 meters away from the vehicle when use remote engine start function.
4. Remote engine cut off: Once the vehicle is remote started, keep pressing the start button for around 3 seconds will remote cut off the engine. Please keep at least 8 meters away from the vehicle when use remote engine cut off function.
5. Panic mode: in arm status, press lock button  once
6. Remote trunk release: Continue to press start button twice.
7. Spare key(default is without, and we recommend you to equip one for future emergency usage)



- 1.Lock/Arm: press lock button  once(turn off PKE function)
- 2.Unlock/disarm: press unlock button  once(turn on PKE function)
- 3.Remote engine start: In arm status, keep pressing the start button for around 3 seconds. Please keep at least 8 meters away from the vehicle when use remote engine start function.
- 4.Remote engine cut off: Once the vehicle is remote started, keep pressing the start button for around 3 seconds will remote cut off the engine. Please keep at least 8 meters away from the vehicle when use remote engine cut off function.
- 5.Panic mode: in arm status, press lock button  once
- 6.Remote trunk release: Continue to press start button twice.
- 7.Spare key(default is without, and we recommend you to equip one for future emergency usage)

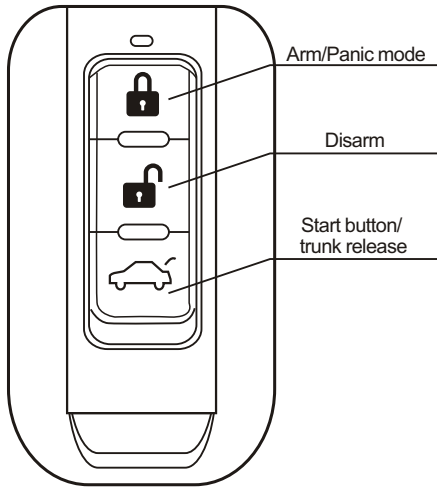

- 1.Lock/Arm: press lock button once(turn off PKE function)
- 2.Unlock/disarm: press unlock button once(turn on PKE function)
- 3.Remote engine start: In arm status, keep pressing the start button for around 3 seconds. Please keep at least 8 meters away from the vehicle when use remote engine start function.
- 4.Remote engine cut off: Once the vehicle is remote started, keep pressing the start button for around 3 seconds will remote cut off the engine. Please keep at least 8 meters away from the vehicle when use remote engine cut off function.
- 5.Panic mode: in arm status, press lock button once
- 6.Remote trunk release: Continue to press start button twice.

Please refer to above key fob button introduction to operate related function accordingly.

Other common used function:

- 1.Mute alarm: Turn off the car, lock/arm the alarm, keep pressing lock button for 3 seconds, turn signal lights flashes twice, siren beeps twice, the alarm is enter into mute alarm function. When the alarm is in mute alarm status, the siren will not beep when lock or unlock the car door.
- 2.Audible alarm (exit mute alarm): Turn off the car, lock/arm the alarm, keep pressing lock button for 3 seconds, turn signal lights flashes once, siren beeps once, the alarm is enter into audible alarm function.
- 3.Valet mode(Car washing mode): Started the car, stepping on foot brake pedal, keep pressing lock & unlock button on key fob at the same time for 5 seconds, siren beeps 5 times and turn signal light flashes 5 times. The alarm is enter into valet mode (car washing mode) & turn off PKE function. When the alarm is in valet mode, user can't use remote engine start function.
- 4.Exit valet mode (car washing mode): Started the car, stepping on foot brake pedal, keep pressing lock & unlock button on the key fob at the same time for 5 seconds, siren beeps 3 times and turn signal light flashes 3 times. The alarm is exit valet mode (car washing mode) & turn on PKE function.

Important: The PKE feature default is turn on. When PKE feature is turn on, press lock button once will turn off the PKE function and lock the car door at the same time. If user want to turn on PKE feature again, just press unlock button once will turn on the PKE function, at the same time the car door is unlocked.

The remote control is an intelligent electronic device with inductive function. Please follow the following instruction to avoid damage.

- 1.Don't put the remote control in an environment with damp, sunshine or high temperature.
- 2.Don't dismantle the remote control. The users can't inspect the components inside.
- 3.To avoid strong strike or heavy crash.

- 4.Don't put the remote control together with the metal keys or avoid damage or signal shielding.
 - 5.Don't put the remote control with cell phone or other products will emit strong signal to avoid the signal interference.
 - 6.When one remote control is using, the other remote control will be in sleep mode to save power. If you want to activate it, press any button on it will activate it.
- If the PKE function of the smart remote control is not working well or the LED indicator is dim or not lit, it's probably due to the battery is low. If so, please check the battery of the remote control and replace it with a new one.

Manual for releasing the steering lock:

1. Please check whether there is steering lock in your vehicle or not, if yes, follow with the next step.
2. Copy a key blade with your factory original key blade and match them so that the copied key blade can start the car.
3. When finish matched, put the copied key blade into the ignition cylinder of car, like this picture,



turn the key to "ON" position.

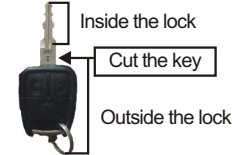

So that the steering lock can be turn round. Then cut and keep 1mm length of the copied key outside of the lock. See the picture:

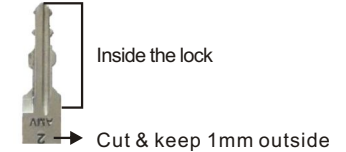

4. Stick the push start button on the lock. (That is the reason for cutting the key.)



Stick on the lock



6. Everything finish like the picture:



7. If you don't want to cut the key for releasing the steering lock, you can make a hole in the car which near the steering and install the push start button .Like the picture, but it will not convenient for you as you need to use the original key to release the steering lock every time you start the car.



8. Un-plug the factory ignition wire harness to avoid which consume the vehicle battery power.

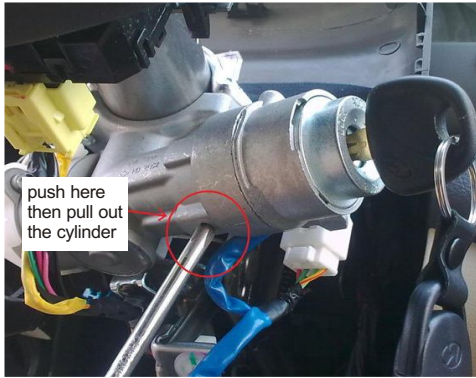

Method 2:

Use a screw driver and push it into the hole of the ignition cylinder (see photo on the left), turn the ignition key to ACC position, then pull out the key with force will take out the ignition cylinder. Then remove wires from ignition switch and put the push start button over the empty key cylinder slot.

Important:

Only a qualified staff can do this as there is risk to lock the steering lock again if the operation is not correct. If you are not a qualified staff, we recommend you to use the method 1 to release the steering lock.

Installation for chip immobilizer

If there is chip immobilizer in original key fobs, please follow below method

Method 1:

1. Take out the original induction coil from the ignition lock.

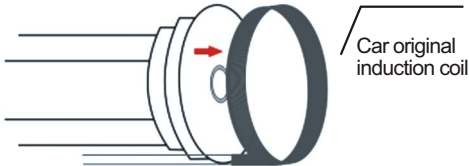

2. Put the car original remote control (include the chip immobilizer) into the coil, make sure the induction of the chip immobilizer and the coil is good.



Reminder: Some chips are with weak signal and is hard to start the car when put on the car original coil. Then need to add a coin or other metal pad underneath the chip to enlarge the signal of it (see above drawing)

Method 2:

1. Take out the chip immobilizer from the car OEM remote control.
2. Take out the original induction coil from the ignition lock.

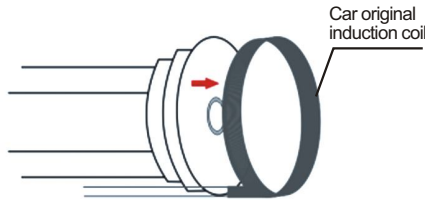

3. Stick the chip immobilizer on the induction of car coil, make sure the induction of chip and coil is good.

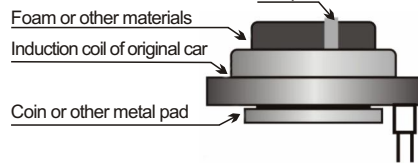

Method 3:

Use an extra bypass module to bypass it, installation steps as below:

1. Put the whole remote control (please remember to take out battery from remote if you do so) include the chip immobilizer into the bypass module.

Note: if size of remote control is big, user can put PCB or chip inside the bypass module.

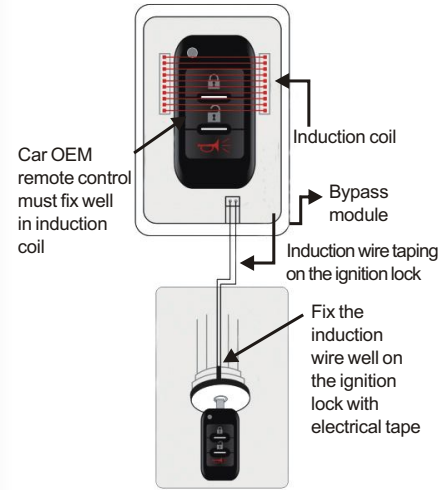

2. Taping induction wires 2-3 circles on the ignition lock header

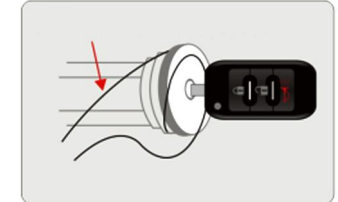

Important: Please fix the car OEM remote control and induction wire well around the ignition lock header to make sure that the car can be started.

Programming method:

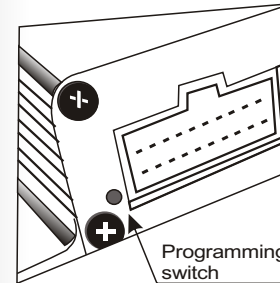

1. In disarm status, keep pressing the programming switch on the control module (refer to programming switch) till turn signal light keep lighting on, this means the alarm is entering into programming status. At this time, take the 1st remote control close to the control module & keep pressing lock button on the first remote control, the turn signal light flash once, this means the first remote control is finished programming.

2. Take the 2nd remote control close to the control module & keep pressing lock button on the 2nd remote control, turn signal light flash twice, this means the 2nd remote control is successfully code learned.

After that, release the pressing on the programming switch and the programming is finished.

User can use this method to add new key fob on the device.

Important:

When you do the programming, please remember to keep pressing the programming switch on the control module all the time till you finish the programming on both remote controls. Once the vehicle is enter programming status, need to finish both key fobs programming in 10 seconds.

The alarm can program 2 key fobs maximum.

The key fob is programmed with the control module already before out of the factory and no need to program them again.

Central Door Locking Wire Connection

Checking your locking system

Please use a diode test lamp (voltmeter) for checking electric currents. Conventional test lamps conduct too high voltage will cause damages to electronic control device. Please take care not to connect the remote control with the "motor wire" of your central locking system as which may lead it to short-circuit danger!

Before installation the door panels again, check the following:

1. Make sure your vehicle key is not inside the vehicle;
2. Attach the battery again;
3. Close the vehicle doors well;
4. Check the functionality of the central locking system by closing and re-opening the doors with your car key, lock the vehicle again.

This item has door lock relays on the PCB and can directly interface with most electric power door lock systems that drawing 20 amps or less. It can also drive aftermarket actuators directly. Some vehicle require that an aftermarket actuator be added to the driver's door to allow system control, see type D wiring section.

IMPORTANT:

Depending on the type of the door lock system, there may be additional wires in the door lock harness and they are not required used in wiring the door locks.

This item has door lock relays on the PCB and can directly interface with most electric power door lock systems that drawing 20 amps or less

For some vehicles, the door locks may be controlled by an optional data bus expansion module. If so, no door lock interface wiring is required.

Identifying the door lock system

The easiest way to determine which type of door lock system you are working with is to remove the master locking switch itself, which is usually on the driver's door or on the center console once you have determine which type of factory door lock circuit you are working with, and the color codes of the switch wires to be used, you can usually simplify the installation by locating the same wires in the vehicle's kick panel. If no central locking switch is found, the installation may require a door lock actuator.

NOTE: Always retest the wires in the kick panel to be sure they function the same way as the wires on the switch.

There are 8 different types of door lock systems (Type A - H). Please search the vehicle-specific wiring instructions online and the chart below to help determine which door lock system your vehicle uses. Most vehicle factory door lock wires is smaller gauge and located in the driver's kick panel or under the driver's dash.

Note: The most common type of door lock systems are Type A positive trigger, Type B negative trigger and Type C reverse Polarity. Other Types D to type H probably require external relays when do the installations.

Type A: Positive trigger with three-wire (+) pulse controlling factory lock relays.

Type B: Negative trigger with three-wire (-) pulse controlling factory lock relays.

Type C: Reverse polarity, positive triggered

Type D: Adding one or more aftermarket actuators. These include central locking systems without an actuator in the driver's door, but with factory actuators in all the other doors. Type D also includes vehicles without power locks, which will have actuators added.

Type E: Electrically-activated vacuum systems. The vehicle must have a vacuum actuator in each door. Making sure that locking the doors from the driver's or passenger side using the key activates all the actuators in the vehicle. This requires a slight modification to the door lock wire harness.

Type F: One-wire system: cut to lock, ground to unlock.

Type G: Positive (+) multiplex. One wire controls lock and unlock using resistor(s).

Type H: Negative (-) multiplex. Same as Type G system, but uses (-) pulse instead.

Here is the EC002 series central door lock wire harness principle:

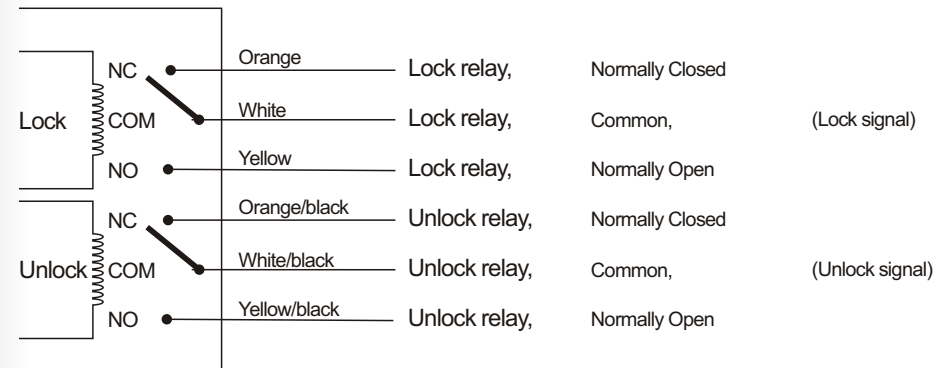

Here is wiring connection method for each type:

Type A: positive trigger with three-wire (+) pulse controlling factory lock relays.

There are 3 wires(+) pulse controlling factory locking relays, one pulses 12v for lock, one pulse 12V for unlock, the last one is for constant 12V.

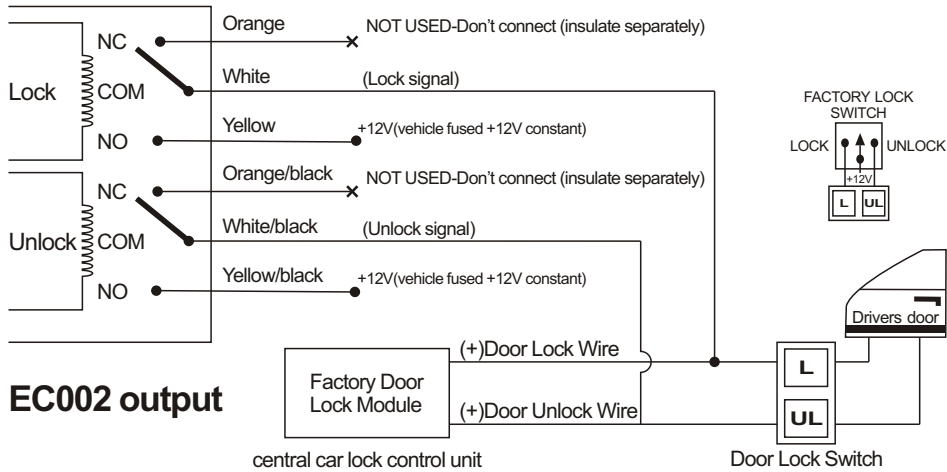

EC002 output

central car lock control unit

Door Lock Switch

Type B: Negative trigger with three-wire (-) pulse controlling factory lock relays.

Two wires resting open circuit, one pulses ground for lock and the other pulse for unlock.

For this kind of trigger, the vehicle switch will have three wires on it, one wire will test ground all the time. One wire will pulse (-) when the switch locks the doors, and the other wire will pulse (-) when the switch unlocks the doors. This type of system is difficult to mistake for any other type.

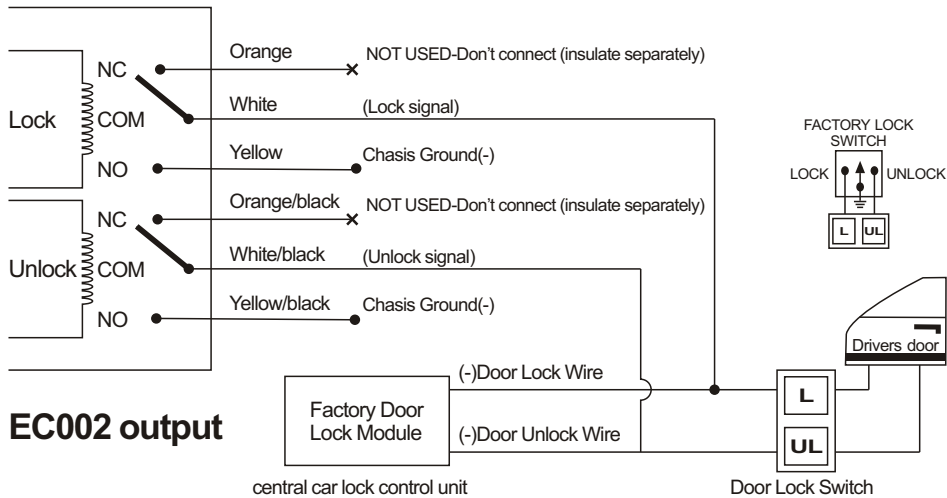

EC002 output

central car lock control unit

Door Lock Switch

Type C: Reverse polarity, positive triggered

Motor interrupt central locking: Two wires resting at ground, one pulse 12V for lock, the other pulses 12V for unlock.

Direct-wired reversing-polarity switches. The switches are wired directly to the motors. This type of system has no factory relays.

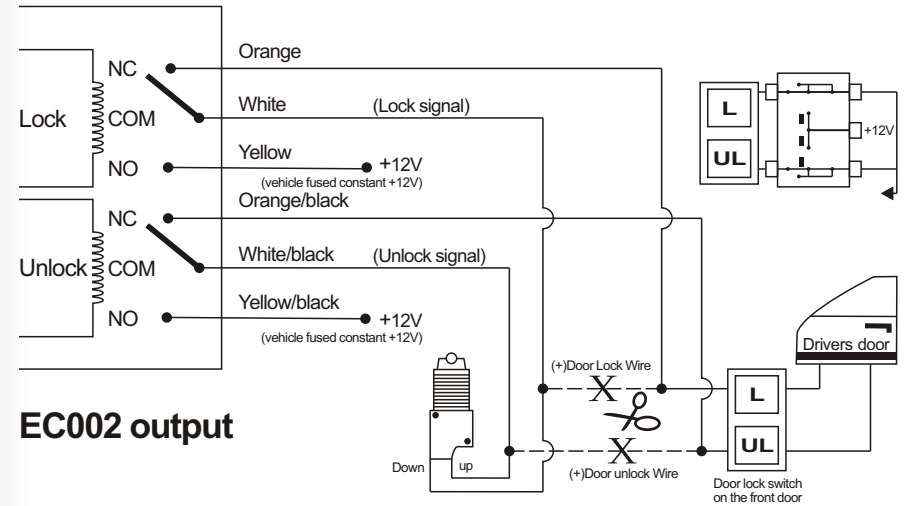

EC002 output

Type D: Adding one or more aftermarket actuators.

For this type of vehicle, there isn't a motor in the driver's door (central locking only operates from the driver's door). An extra door actuator is required.

These include central locking systems without an actuator in the driver's door, but with factory actuators in all the other doors. Type D also includes vehicles without power locks, which will have actuators added.

Vehicles without factory power door locks require the installation of one actuator on each door. This requires mounting the door lock actuator inside the door. Other vehicles may only require one actuator installed in the driver's door if all door locks are operated when the driver's lock is used.

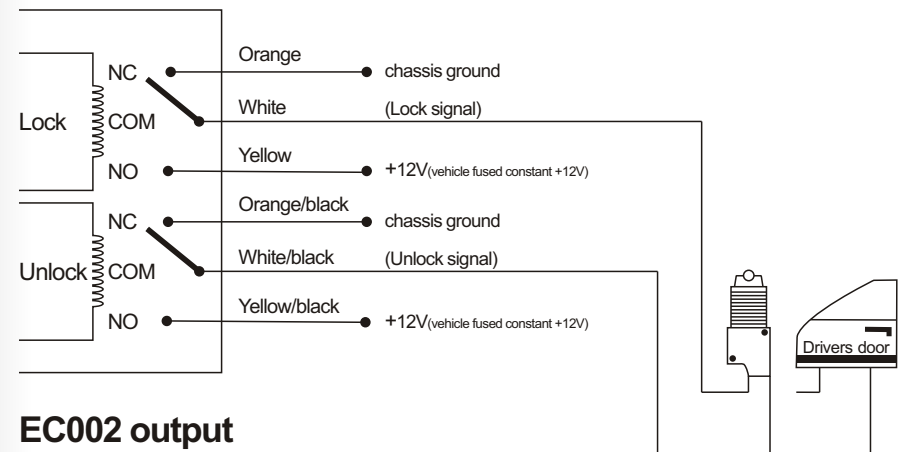

EC002 output

Type E: Electrically-activated vacuum systems.

Polarity reverses on a single wire to lock and unlock. Please set the door lock/unlock time to 3.5 seconds.

The vehicle must have a vacuum actuator in each door. Making sure that locking the doors from the driver's or passenger side using the key activates all the actuators in the vehicle. This requires a slight modification to the door lock wire harness.

The door locks are controlled by an electrically activated vacuum pump. The control wire will show +12v when doors are unlock and (-) ground when locked.

NOTE: For this kind of central door locking, must program the lock pulse time to be 3.5 seconds.

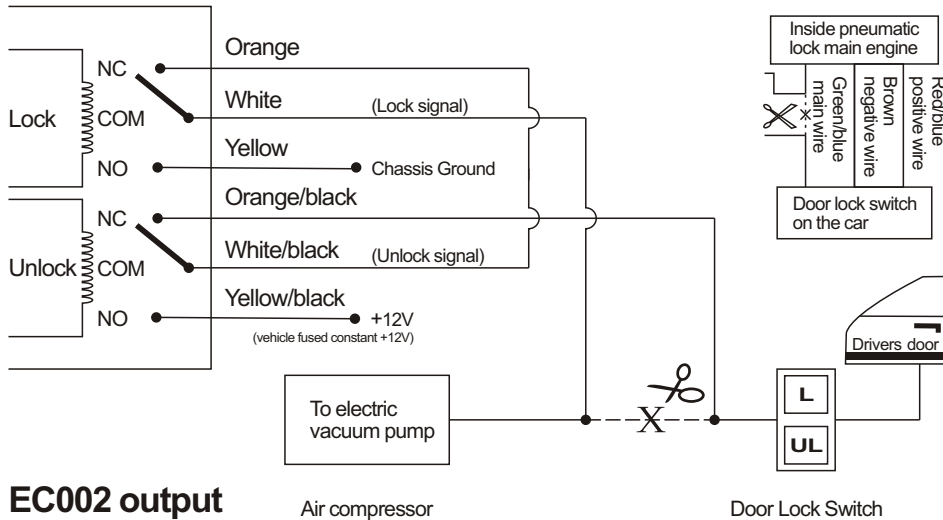

EC002 output

Air compressor

Door Lock Switch

Type F: One-wire system - cut to lock, ground to unlock.

This types of central door locking system mainly for Japanese driven

Single wire in series negative trigger.

Single wire that pulses negative to unlock, and open circuit to lock.

This type of door lock system usually requires a negative pulse to unlock, and cutting the wires to lock the door.(for some vehicles, these are reversed).

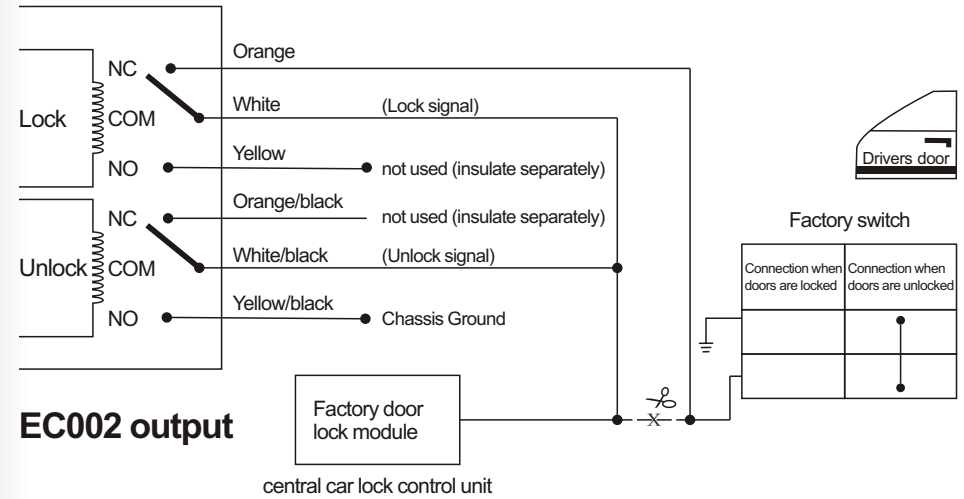

EC002 output

central car lock control unit

Type G: Positive (+) multiplex. One wire controls lock and unlock using resistor(s).

Single wire positive central locking

Single wire, positive lock, positive unlock.

Two potential (resistor may require) positive trigger.

Single-resistor style: if one resistor is used in the door lock switch/key cylinder, the wire will pulse (+) 12V in one direction and less than +12V when operated in the opposite direction.

Two resistor type: if two resistors are used in the factory door lock switch/key cylinder, the switch/key cylinder will read less than +12V in both directions.

Determining the proper resistor values: to determine the resistor values, the door lock switch/key cylinder must be isolated from the factory door lock system. For testing, use a calibrated digital multi-meter that is set to ohms.

IMPORTANT: to ensure an accurate resistance reading, do not touch the resistor or leads during testing.

1. Cut the output wire from the door lock switch/key cylinder in half;
2. Test with the meter from the switch side of the cut door lock switch/key cylinder wire to a reliable constant +12V source. Some good constant +12V references are the power input source to the door lock switch/key cylinder, the ignition switch power wire, or the (+) terminal of the battery.
3. Operate the door lock switch/key cylinder in both directions to determine the resistor values. If the multi-meter displays zero resistance in one direction, no resistor is need for that direction.
4. Once the resistor value(s) is determined, refer to the wiring diagram for proper wiring.

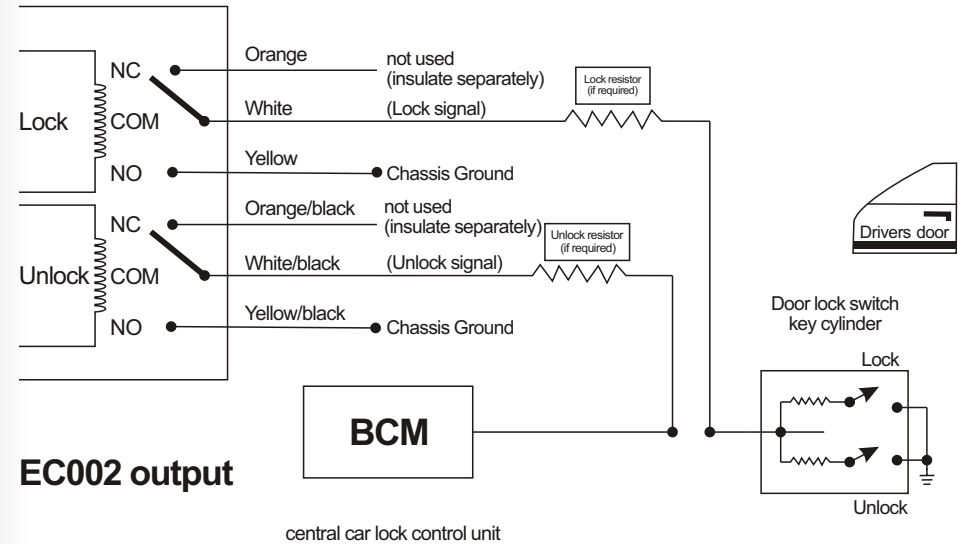
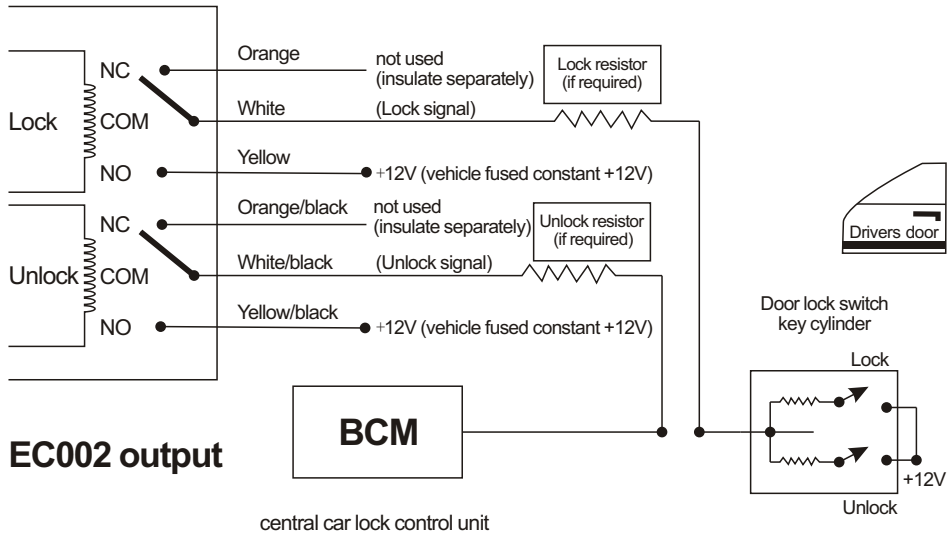

Type H: Negative (-) multiplex. Same as Type G system, but uses (-) pulse instead.

Single wire negative central locking

Single wire, negative lock, negative unlock.

Two potential (resistor may require) negative trigger.

Single-resistor style: if one resistor is used in the door lock switch/key cylinder, the wire will pulse ground in one direction and resistance to ground when operated in the opposite direction.

Two resistor type: if two resistors are used in the factory door lock switch/key cylinder, the switch/key cylinder will read resistance to ground in both directions.

Determining the proper resistor values: to determine the resistor values, the door lock switch/key cylinder must be isolated from the factory door lock system. For testing, use a calibrated digital multi-meter that is set to ohms.

IMPORTANT:

To ensure an accurate resistance reading, do not touch the resistor or leads during testing.

1. Cut the output wire from the door lock switch/key cylinder in half;
2. Test with the meter from the switch side of the cut door lock switch/key cylinder wire to a reliable ground source. Some good ground references are the ground input source to the door lock switch/key cylinder, or the battery ground.
3. Operate the door lock switch/key cylinder in both directions to determine the resistor values. If the multi-meter displays zero resistance in one direction, no resistor is need for that direction.
4. Once the resistor value(s) is determined, refer to the wiring diagram for proper wiring.

Wiring Diagram of EASYGUARD EC002

3 color wire (see Note 8) or shock sensor (see note 9)
 Note 8:
 If the alarm equip with 3 color wire, which is used to connect with immobilizer bypass wire or GWR status wire or status output wire
 Choose one method as below:
 No need to connect orange wire for all

below method:
 Method 1: Cut off the car factory chip immobilizer wire into 2 parts, each end connect with the white & yellow wire respectively,
 Method 2: If there is GWR (-) wire, connect the GWR(-) wire with white wire and connect yellow wire with ground(GND)
 Method 3: If there is key sense wire which require either ground (-) or positive (+) wire, connect the key sense wire with white wire and connect the yellow wire with ground (-) or +12V respectively.



Push start button

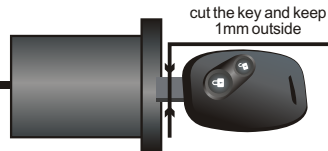
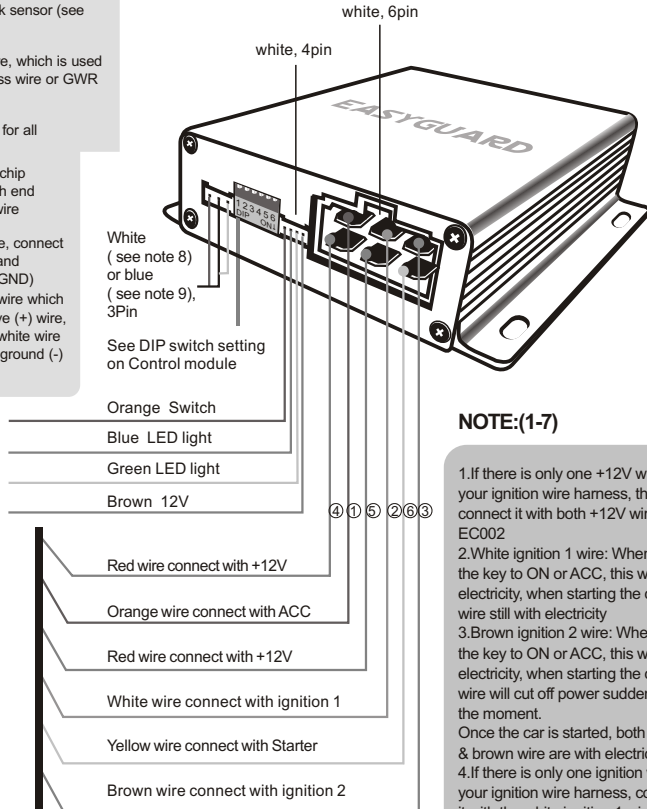

Note 9:
 If the alarm is equip with shock sensor, then connect with shock sensor. If so, there will be no GWR wire in the kit and you can use the SPST relay to have a GWR wire. Method is as right diagram:

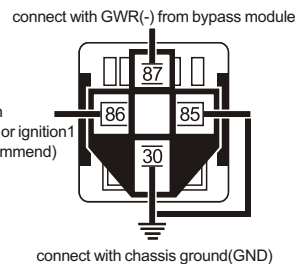

You can also use a SPDT relay to have a GWR wire and wiring method is the same but no need to connect 87a on SPDT relay.

NOTE:(1-7)

- 1.If there is only one +12V wire in your ignition wire harness, then connect it with both +12V wires in EC002
- 2.White ignition 1 wire: When turn the key to ON or ACC, this wire with electricity, when starting the car, this wire still with electricity
- 3.Brown ignition 2 wire: When turn the key to ON or ACC, this wire with electricity, when starting the car, this wire will cut off power suddenly at the moment.
- 4.If there is only one ignition wire in your ignition wire harness, connect it with the white ignition 1 wire, no need to connect the brown ignition 2 wire
- 5.If there are 2 ACC wire in your ignition harness, connect both ACC wires with orange wire in EC002
- 6.If there are 2 starter wires in your ignition harness, connect both starter wire with yellow wire in EC002.
7. If your car is newer cars that no ACC(only ON & OFF), connect the orange ACC(Accessory) wire and white ignition 1 wire in EC002 wire harness with ignition 1 wire in your vehicle.

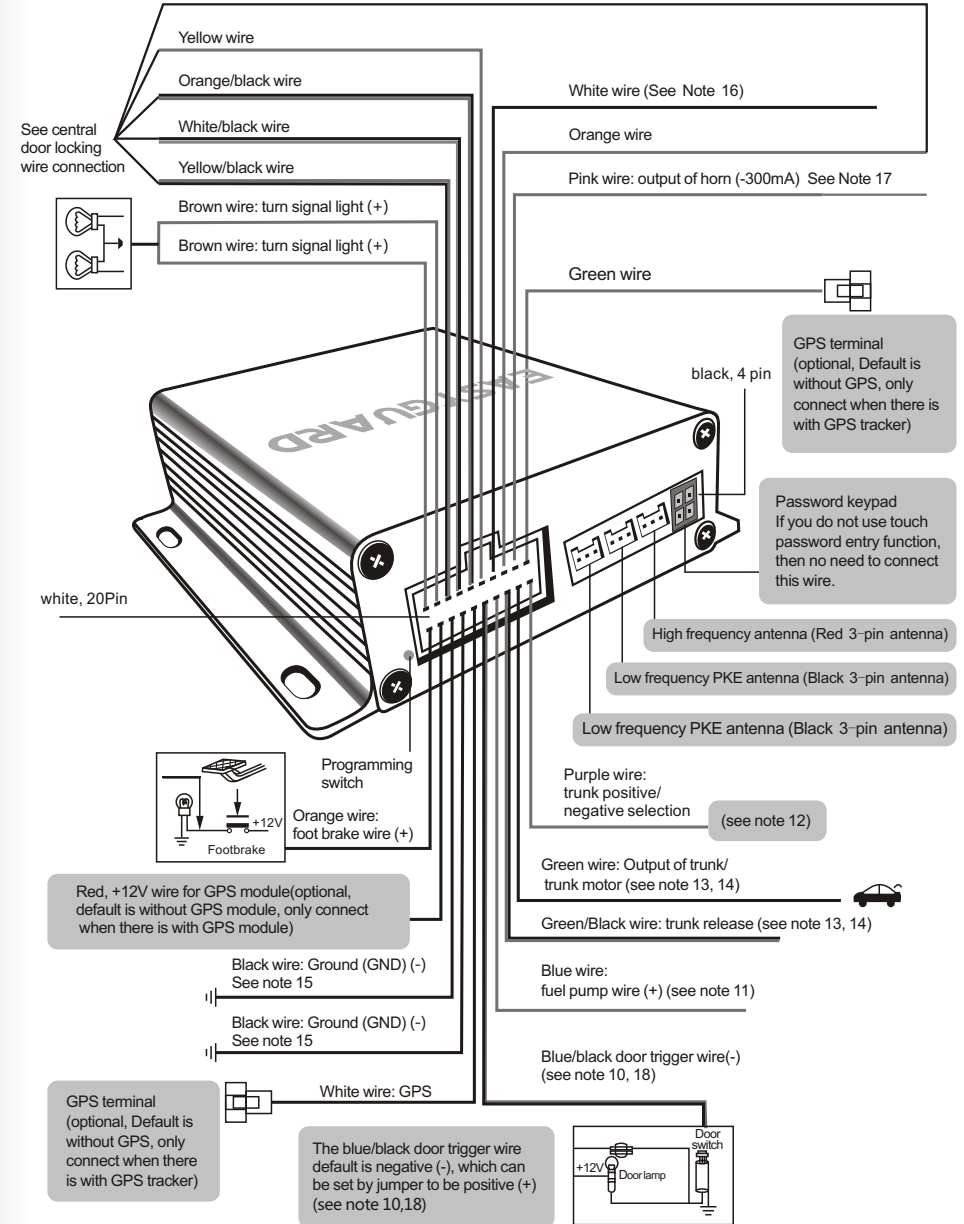

IMPORTANT TIPS:

- 1.Connect the black chassis ground wires first when making wire connection to avoid damage on the device
- 2.Once you finish all wire connection, test the function first and remember to use the electrical tapes or strips to tighten all the wire connection to avoid any poor connection between the control module & wire harness.

Function description:

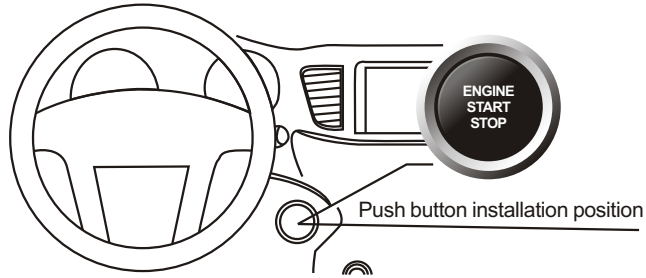

1. Push button start/stop

A. When step on foot pedal

1. In disarm status, step on foot pedal, the push button blinks blue color (or red color per the push start button style you choose), short press the push button once, the vehicle will be started. The push button will turn to green color (or red color per the push start button style you choose).

Once the vehicle is started, step on foot pedal and press the push button 0.5 second will stop the vehicle. At the same time, ACC and ON will be turn off and the push button will turn to blue color (or red color per the push start button style you choose) if the key fob still in PKE induction range.

If the key fob is out of PKE induction range, the push start button will turn off.

2. If the push start button was broken or destroyed or in other situation that unable to use. User can start or stop the vehicle with below steps:

In disarm status, step on foot pedal, keep pressing start button on the remote control for 3 seconds, the vehicle will be started.

Step on foot pedal, keep pressing start button 3 seconds on the remote control will cut off the engine and turn off ACC & ON.

B. When do not step on foot pedal

1. In disarm status, do not step on foot pedal and short press the push button once will turn on ACC. Press the push button once again will turn on ACC & ON dashboard and press it once again will turn off ACC & ON.

In disarm status, do not step on foot pedal, keep pressing the push start button for 3 seconds will turn off ACC and ON dashboard and the vehicle engine will be stopped. The push button will turn to blue color (or red color per the push start button style you choose) if the key fob still in PKE induction range.

If the key fob is out of PKE induction range, the push start button will turn off.

C. Keep pressing the button to start the vehicle

In cold winter or other special situation, user can keep stepping on foot pedal and keep pressing the push button for 5 seconds to start the vehicle till the vehicle is started. The maximum pressing engine start button time is 5 seconds. If press 5 seconds but still not able to start the vehicle, please try it again.

Notes: Once the vehicle is armed, then not able to start the vehicle by the push button but need to disarm first then press the push button to start the vehicle.

D. Remote engine start for back up purpose:

For some special situation such as there is no brake signal or the brake fuse was failed to work, user can use remote engine start function to start the vehicle, method is keep pressing start button on key fob for 3 seconds will remote start the vehicle, and once the vehicle is started, user keep pressing start button for 3 seconds will cut off the vehicle engine. When use remote engine start/stop function, please keep at least 8 meters away from the vehicle when PKE feature is turn on.

2. PKE (passive keyless entry)

Lock: Turn off the engine, exit the vehicle and close all doors well and walk away from the vehicle for 3-5 meters away with the key fobs, the alarm siren will beep once and turn signal light flashes once to confirm, at the same time will lock the door & arm the vehicle automatically. At the same time, the push button turn off and the vehicle window will roll up automatically (extra window closer module is required for some cars).

Unlock: When user approach the vehicle in 1-2 meters with key fob in hand or pocket, the turn signal light turn on 1 second to confirm, at the same time, the alarm is disarm & car door automatically unlock. The push button turn to blue color (or red color per the push engine start button style you choose). The user can open car door and get in the vehicle directly.

3. Manual arm/lock

Short press lock button  once will lock the vehicle door, turn signal light flashes 1 second and siren beeps once. At the same time, will turn off PKE function, the push button also turn off and the vehicle window will roll up automatically (extra window closer module is required for some cars).

4. Manual disarm/unlock

Short press unlock button  once will unlock the vehicle door, turn signal light turn on 1 second, the vehicle is disarmed and car door is automatically unlocked. The push start button will turn on blue (or red color per the push start button style you choose) and PKE function will turn on at the same time.



5. Mute alarm & audible alarm

Turn off the vehicle, lock/arm the alarm, keep pressing lock button for 3 seconds, siren beeps twice, the alarm is enter into mute alarm function.

Audible alarm (exit mute alarm): Turn off the vehicle, lock/arm the alarm, keep pressing lock button for 3 seconds, siren beeps once, the alarm is enter into audible alarm function.

6. Remote trunk release

Continue to press trunk release button  twice will remote release car trunk, turn signal light will flash 3 times at the same time.

If there is no trunk release button  on the remote control, press start button or siren button  twice will release car trunk.

The default trunk release output is 2.5 seconds, if your trunk require 3 seconds output time, press down DIP switch 2 on control module in power off status(see DIP switch setting on control module)

7. Panic mode/Car finding

In arm status, press lock button  once, turn signal light flashes 5 times and siren beeps 5 times to indicate car location. Press the lock button once again will stop. Siren will not beep when the alarm is in mute alarm status.

8. To enable or disable PKE feature (PKE ON/OFF setting)

To disable PKE feature(valet mode): Started the vehicle, stepping on foot brake pedal, keep pressing lock & unlock button on key fob at the same time for 5 seconds, siren beeps 5 times and turn signal light flashes 5 times. The alarm is enter into car valet mode & disable the PKE feature.

To enable PKE feature (exit valet mode): Started the vehicle, stepping on foot brake pedal, keep pressing lock & unlock button on the key fob at the same time for 5 seconds, siren beeps 3 times and turn signal light flashes 3 times. The vehicle is exited valet mode & enable PKE feature.

Important: The PKE function default is turn on. When PKE function is turn on, press lock button once will turn off the PKE function and lock the vehicle door at the same time. If user want to turn the PKE on again, just press unlock button once will turn on the PKE function, at the same time the vehicle door is unlocked temporary.

9.Remote engine start/stop

For a 3 button remote control, the button except lock button and unlock button is the start button.

For a 4 button remote control the button except lock , unlock & trunk release button is the start button (usually is siren button)

The alarm has two modes for remote engine start, automatic gear car and manual gear car, please remember to select correct DIP switch selection on the control module. Default setting is for automatic gear car with switch 5 in control module is press down.

When user use remote engine start function, please pay attention to following points:

- (1) Never remote start the vehicle with the vehicle in gear, and
- (2) Never remote start the vehicle with the keys in the ignition. The user will be responsible for having the neutral safety feature of the vehicle periodically checked, where in the vehicle must not remote start while the vehicle is in gear. This testing should be performed by an authorized EASYGUARD dealer or a professional car alarm installer in accordance with the safety checking stated in this product installation guide. If the vehicle starts in gear, cease remote start operation immediately and consult with the user to fix the problem immediately.
- (3). When use remote engine start function, the gear selector should in Neutral (N) or Parking (P) position. If your vehicle is manual transmission, please refer to remote engine start for manual gear car.

Remote starters for manual transmission pose significant risks if not properly installed and operated. When testing to ensure the installation is working properly, only remote start the vehicle in neutral gear, on a flat surface and with a functional, fully engaged parking brake. Do not allow anyone to stand in front of or behind the vehicle.

- (4). EASYGUARD electronics will not bear any responsibility for the loss caused by the running of the vehicle after remote engine start.

1.Remote engine start for automatic gear car:

In arm status, keep pressing the start button on the remote control for 3 seconds will remote start the vehicle. When doing this, please keep a distance of at least 8 meters away from the vehicle (User is not able to use remote engine start function if in PKE induction area). Siren will beep 3 times and turn signal lights will flash 15 times when car is remote started. If user approached the vehicle with key fob within PKE induction range, turn signal light will stop flashing. And the door will be automatically locked once vehicle is started.

The started engine will keep on running for 15 minutes then turn off automatically if user doesn't unlock the vehicle doors within 15 minutes.

While the engine is remote started, if user approach the vehicle within 1-2 meters with the remote control, the door will unlock and the alarm will disarm automatically. The user may drive the vehicle directly and there is no need to start the engine again.

While the engine is remote started, If user approach the vehicle within 1-2 meters with the remote control but not open car door, then walk away from the vehicle for more than 5 meters away, the vehicle will be automatically cut off engine and turn off ACC, ON and enter into arm status.

While the engine is remote started, If user approach the vehicle within 1-2 meters with the remote control and open car door, then walk away from the vehicle for more than 5 meters away with remote control, the vehicle engine will not cut off and turn signal light will keep lighting on to remind user to close the door well.

Any illegal door opening will trigger the alarm if without induction of the remote control.

Once the vehicle is remote engine started, keep pressing the start button on remote control for 3 seconds will remote cut off the engine and also turn off ACC & ON. The vehicle will enter into arm status.

2.Remote engine start for manual gear car:

If the engine is stopped by pressing the push start button then user can't use remote engine start function. If user want to start the engine with remote control, please set with below procedure:

Un-plug the 6-Pin ignition wire harness from the control module

Press up DIP switch 5 on control module to set the alarm fit for manual transmission car

Re-plug the 6-Pin ignition wire harness with the control module

Park the vehicle, shift the gear selector to Neutral position, pull the hand brake ON, do not turn off the vehicle engine in the vehicle with the push start button, exit the vehicle and close all the doors well, walk away from the vehicle at least 5 meters away, then keep pressing the start button for 3 seconds to turn off the engine. Then next time user can use the remote control to use remote engine start function. (This is to avoid accident for manual gear cars if the gear selector is not in neutral position when starting the engine with remote control).

Important: Factory default setting of this system is with remote engine start for automatic gear cars. If your car is manual gear cars and want to use the remote engine start function. Please follow with above instructions. Our company will not bear any responsibility for the loss caused by the running of the vehicle after remote engine start.

10. Dome light supervision (optional)

If you want to use dome light supervision, please follow with below instruction:

- a.Dis-connect the blue/black door trigger wire in 20 pin wire harness with the door trigger wire in your vehicle
- b.Un-plug the 6 pin ignition wire harness to cut off power of the device first
- c.Press down DIP switch 2 on alarm control module & wait for around 5 minutes
- d.Re-plug 6 pin ignition wire harness to re-power the device.

Then you should able to use dome light supervision function now.

If you connect the blue/black door trigger wire with the door trigger wire in your vehicle, the turn signal light will flash when opening the car door.

If you dis-connect the blue/black door trigger wire with the door trigger wire in your vehicle, the turn signal light will not flash when opening the car door.

11. Anti-hijacking

The alarm default is turn on anti-hijacking function with Switch 4 on control module is press down.

Once anti-hijacking function is turn on, when the vehicle is running, user get off the vehicle then close the door well and take the remote control away. The alarm will try to detect remote control signal after 30 seconds, if still unable to detect the remote signal in 1 minute, the alarm will alarm with siren beeps and turn signal flashes and car engine will cut off automatically in 40 seconds.

If user turn off anti-hijacking function, when the vehicle is running and remote control (key fob) was taken away, the alarm will be automatically set to arm status once the vehicle is stop and open then close car door. After that, the vehicle will be unable to start except the alarm detect the remote control nearby. User can input password to get in the vehicle and start the vehicle.

12. Alarm trigger by illegal door opening

When the vehicle is in arm status, if the vehicle door is opened illegally, it will trigger the alarm and siren will sound and turn signal light flashes rapidly.

13. Central door locking automation

Close the door well, starting the vehicle, step on the foot pedal, the central door will automatically lock the vehicle door after 15 seconds. Once the vehicle is stopped & engine turn off, the central door will automatically unlock.

When vehicle engine is running and there is passenger get off the vehicle, then close the door well, step on foot brake pedal and start the vehicle, the central door will automatically lock the vehicle door after 15 seconds.

When the vehicle is running, press unlock button  once will unlock the central door system.

Turn off central door locking automation: When the vehicle is started, open car doors, quick step on foot brake 5 times in 5 seconds, siren beeps twice will turn off the central door locking automation function.

Turn on central door locking automation: When the vehicle is started, open car doors, quick step on foot brake 5 times in 5 seconds, siren beeps once will turn on the central door locking automation function.

The alarm default setting is turn on central door locking automation function

14. Touch password entry

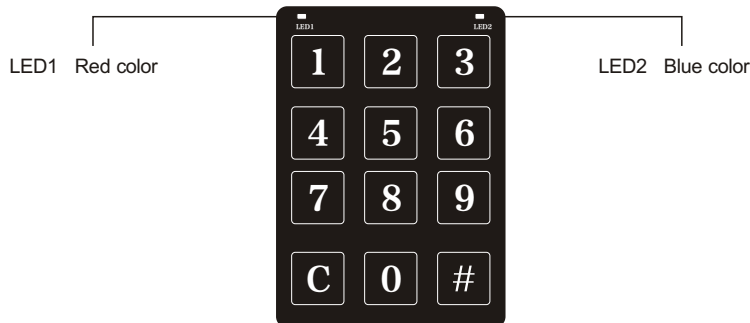

Color changes with different operation on the password keypad

Action/Status	LED1(red color)	LED2(blue color)	Engine start/stop button color
Armed/locked	Turn off	Blinks slowly	Turn off
Disarmed/unlocked	Turn off	Turn off	Turn on(blue/red)
When input password to unlock (Input C0#+6 digital number)	Blinks once to confirm if the input is valid Not blink if the input is invalid	Keep lighting on	Turn off
When input password to lock (Input C0#+6 digital number)	Blinks once to confirm if the input is valid Not blink if the input is invalid	Keep lighting on	Turn on(blue/red)
When finish input right password	Turn off	Blinks 3 times to confirm then turn off	Color changed, turn on/off
When finish input wrong password	Turn off	Turn off directly	Not change, turn on/off

The alarm is equipped with touch password keypad, which is mount inside of the front windshield and user can input password outside the vehicle to lock or unlock car door.

If you do not want to use the touch password entry function, you can choose not to install the touch password keypad. We recommend you to install it for backup usage.

When the vehicle is armed, user can disarm the system and unlock the vehicle door with the remote control or input the password preset to disarm and unlock the vehicle door. However, if the remote control is low battery or malfunction or lost, then user can use the touch password entry function to unlock and lock the vehicle.

Factory default password is 123456.

a. Use touch password to unlock the vehicle:

1. Input C0#+6 digital number password (factory default setting password is 123456) in turn. Every time you input, the red LED1 on the password key pad will blink once to indicate that the input is valid, if the red LED1 not blink, please re-input again.
2. Once you finish input C0#, the blue LED2 will illuminate continuous, then you can input the 6-digital number password (from 0 to 9) one by one. Every time you input, the red LED1 will blink once to confirm the input is valid.
3. If password is correct, once you finish the input, the blue LED2 will blink 3 times, then turn off, the door will be automatically unlocked and user can get in the vehicle and drive your car away.
4. If the password is not correct, the blue LED2 will turn off directly and you need to try once more time again.
5. If you input wrong number, please press C button once to cancel.
6. If you continue to input wrong password for 5 times, the password entry function will be locked for 1 hour. And please try again after 1 hour. If user approach the vehicle with remote control when PKE function is turn on, the system will automatically unlock the vehicle door.

7.If you use password entry function to unlock the vehicle but not open and close the vehicle door in 15 seconds, the door will be re-lock automatically after 15 seconds.

8.If you unlock car door by password and open but forget to close the door, the siren will beep for every 5 seconds to remind you to close the door well.

b.Use touch password to lock the vehicle:

1.Stop the vehicle and close the door well, user stand outside the vehicle and input C0#+6 digital password in turn. Every time you input, the red LED1 on the password key pad will blink once to indicate that the input is valid, if the red LED1 not blink, please re-input again.

2.If password is correct, once you finish the input, the blue LED2 light will blink 3 times, then turn off. The vehicle door will be automatically locked.

3.If the password is not correct, the blue LED2 will turn off directly and you need to input the password again.

4.If you input wrong number, please press C button once to cancel.

If user lost the remote control or put the remote control in the vehicle, then can input password to lock the vehicle door.

c.Password revision, please follow with below steps:

1. In disarm status, turn on ACC or ON, continue to press unlock button  on remote twice, the blue LED2 on the keypad is illuminated continuously, this indicate the system is enter into password revision status.

2. Type in factory-set password (123456) directly(no need to input C0#), every time you input, the red LED1 will blink once to confirm the input is valid, once you finished input, then blue LED2 will blink 3 times and horn sounds once to confirmed the old password is correct. Then the blue LED2 on the password keypad is illuminated continuously again.

3. Type in new six digital number password (from 0 to 9) and blue light blinks 3 times. Then illuminated continuously again.

4. Input the 6-digital number new password once again, then blue LED2 blinks 3 times again and then turn off, at the same time the siren beeps 3 times if car siren is connected with the alarm. This means new password correct revised and confirmed.

5. If the password not match with the password as step 3 input, the blue LED2 will turn off directly and password not succeed revised.

6. Now input C0#+new 6 number revised password to see if you can unlock or lock car door with the new password. If yes, it means that the new password is revised successfully. If not, please check with above steps again.

Reminder: as the password entry keypad is a touch keypad, so every time when you input a password, the red LED1 will blink once to confirm it, if the red LED1 not blink, this means the password not enter successfully, and need to re-input it again.

Reminder:

If you install the touch password keypad, please remember to revise the password once you finish the installation.

d.Password re-set

If you forget the password, you need to re-set the password to default password first, operation is as below:

1. Make sure the remote control is in PKE detecting range and disarm the vehicle

2. Continue to press the programming switch (please refer to Programming switch in the user manual) for at least 10 times, then you will heard the siren beeps 3 time, this means the password changed to default password 123456 already.

3. Then follow with above password revision steps to revise the password to a new one.

Important: If user use the remote control to lock or unlock the vehicle, then you can use the remote control & touch password key pad to unlock or lock it.

15.Power off memory

If the vehicle was cut off power suddenly, the vehicle will be automatic back to the previous status when re-power.

16.Door unlock well warning

When the user walk away from the vehicle with remote control but not properly close the door well, turn signal will flash 3 times and siren beeps 3 times to remind the user to close the door well.

17.Alarm reminder

Once the vehicle is triggered in alarm status, when disarm it, siren will beep once and turn signal light will flash 3 times to remind the user.

18.Door opening while driving warning

When the vehicle is running but door is opening, turn signal light will flash to remind other vehicle behind. If the vehicle door is closed, the turn signal light will stop flashing.

19.ACC ON warning

When ACC ON is turn on and remote control was taken away, siren will beep to remind user to turn off it.

20.Emergency override

If the remote control was lost, and user also forget the password preset, need to do an emergency override to use the vehicle. Step is as below:

Using mechanical key to unlock the vehicle door (will trigger the alarm), then open car door, keep stepping on foot brake pedal, keep pressing the programming switch on control module for 5 seconds will emergency override the alarm and can start the vehicle now.

Important: once the vehicle is emergency override, all the alarm function will lost at the same time.

21.Power saving & car battery low power protection

Once the remote control not been used for more than 36 hours or the vehicle battery is lower than 11.8V, the system will enter into sleep mode automatically and turn off PKE function to save power.

22.Automatic window closing(optional)

Turn off the engine, get off the vehicle and close all the doors well. After locking the doors and arming the vehicle, the system will detect whether the windows are closed or not and roll up the unclosed windows automatically. (Note: some cars need extra window closer module to fulfill this function)

Warning: When you leave the vehicle with remote control and lock the vehicle door, please make sure that there is no passenger, especially child whose body is staying on the slide rail of the open window to avoid any injury.

23.Vibration alarm(optional)

The vehicle default is without shock sensor and has no vibration alarm function. User can choose to equip with shock sensor version.

Once the vehicle is equip with shock sensor and in arm status, any hit or force on the vehicle will trigger the alarm and siren beeps 5 times, turn signal light flashes 5 times at the same time.

24.GPS tracker(optional)

The alarm is with GPS tracker output and can add a GPS tracker on it (only compatible with Easyguard GPS tracker). User can track the vehicle via smartphone (only compatible with IOS & Android system smartphone) or online tracking and more function via the smartphone. For more information about the GPS tracker, please refer to the GPS user manual.

The alarm default setting is without GPS tracker, if user want to add one, please contact us.

25.Parameter time prolong setting

1.Enter parameter setting status:

In disarm status, close all car doors well, step on foot brake pedal, quick press lock button  5 times, siren beeps 5 times at the same time, then the siren continue to beeps another 5 times, this means the system is enter into parameter setting status.

2.Lock signal prolong setting

Do not step on foot brake pedal, press lock  button once, siren beeps once, means lock signal prolong 1 second.

Do not step on foot brake pedal, press lock button  twice, siren beeps twice, means lock signal prolong 2 seconds.

Do not step on foot brake pedal, press lock button  3 times, siren beeps 3 times, means lock signal prolong 3 seconds.

The rest can be done in the same manner

The device maximum support press lock button  8 times and siren beeps 8 times, means lock signal prolong 8 seconds.

If press lock button  more than 8 times, siren not beep and user need to follow with point 5 to exit the parameter setting procedure.

3.Unlock signal prolong setting

Do not step on foot brake pedal, press unlock  button once, siren beeps once, means unlock signal prolong 1 second.

Do not step on foot brake pedal, press unlock button  twice, siren beeps twice, means unlock signal prolong 2 seconds.

Do not step on foot brake pedal, press unlock button  3 times, siren beeps 3 times, means unlock signal prolong 3 seconds.

The rest can be done in the same manner

The device maximum support press unlock button  8 times and siren beeps 8 times, means unlock signal prolong 8 seconds.

If press unlock button  more than 8 times, siren not beep and user need to follow with point 5 to exit the parameter setting procedure.

4.Starting time(Cranking time) prolong setting

Do not step on foot brake, press start button on the remote control once, siren beeps twice, means starting time is prolong 0.5 seconds and become 1.3 seconds(default starting time is 0.8 second)

Do not step on foot brake, press start button on the remote control twice, siren beeps 3 times, means starting time is prolong 1 seconds and become 1.8 seconds

Do not step on foot brake, press start button on the remote control 3 times, siren beeps once, means starting time is back to default starting time 0.8 second.

5. Exit the parameter setting

Close the door well, step on foot brake pedal, quick press lock button  on key fob 5 times, at the same time, the horn beeps 5 times, then continue to beep another 5 times, this means the system save setting and exit the parameter setting procedure.

6. Back to factory default setting

In disarm status, close all doors well, step on foot brake pedal and quick press lock button  on key fob for 10 times, siren beeps 10 times and continue to beep another 10 times. This means all prolong setting data is change to factory default setting.

Important: No matter you want to do 1 prolong setting or more, you need to enter the parameter setting first, and after you finish setting, please remember to exit the setting.

Technical Parameter:

Control module

Working Voltage: DC12V+/-2V
Static current: <20mA
Induction emit current: <45mA
Frequency: 433.92Mhz 125Khz

Remote control

Working voltage: DC2-3.5V
Static current: <8uA
Battery specification: CR2032 Lithium battery
Working frequency: 433.92Mhz 125Khz
Code method: Rolling code (hopping code)

Starting system

Working Voltage: DC12V+/-2V
ACC current: 30A
ON current: 30A
Starting current: 30A

Touch password keypad:

Working voltage: DC5V
Working current: <8mA
Static current: <10uA

FAQs of EC002

Dear Customer,

Thank you for purchasing our products. Here is some FAQs for your reference, if there is question when installation/ using the products, we recommend you to read the FAQs to find answer and solutions first. If those FAQs still unable to help you fix the problem, you can also contact us and we will help you fix it till everything is working well.

1.How to use password entry function to unlock car?

Please refer to a.use touch password to unlock the car door on page 38-39 in user manual.

2.How to revise password on the touch password key pad?

Please refer to c.password revision on page 39 in user manual.

3.If I forget the password I set, how to re-set it again?

Please refer to d.password reset instructions on page 39-40 in user manual.

4.When I attempt to start the car, it start but shut off a few seconds, what's the reason?

There are possible 4 reasons:

A.The blue fuel pump wire in 20 Pin wire harness not connect well which lead to there is no electricity when you want to start the vehicle. The fuel pump wire is recommend to connect with the fuel pump wire or oil pump wire /oil path motor /sucker motor/ in the vehicle, if you can't find these wire in the vehicle, you can connect it with the constant +12 wire or tach wire.

B.The starting time is not enough. If so, you need to prolong the starting time. For detailed instruction, please refer to engine cranking time in parameter time prolong setting in the user manual.

C.Please check whether the yellow starter wire in 6 Pin wire harness is well connected

D.If there is chip immobilizer in your vehicle factory key fob, you should add an extra bypass module, please make sure the bypass module is well installed and connected in order that you can start your vehicle.

5.I am not able to use remote engine start function, what's the reason?

Please check if the blue fuel pump wire in 20 Pin wire harness is correctly connected or not.

The alarm default setting is for auto gear car and switch 5 in the control module is press down. If your vehicle is manual gear car and you want to use remote engine start function, please press up the switch 5 in power off status (that's un-plug the 6P ignition wire harness from the control module, then press up Switch 5, then re-plug the 6P ignition wire harness with the control module), and set it to manual gear car shift first.

Once the kit is set to manual gear car shift, driver goes out of the vehicle and close doors without flameout, walk away from the vehicle for at least 8 meters, keep pressing the start button on the remote control for around 3 seconds to shut down the vehicle. After that, the user can use remote engine start function for manual gear car.

The hand brake should be in neutral position when use the remote start function for a manual gear car.

User also can refer to the info of remote start for manual gear car in the user manual.

6.Does the device has anti-hijacking function?

Yes, The alarm default setting is with anti-hijacking function and DIP switch 4 in the control module is press down, if you do not want this function, please press up the DIP switch 4 in the control module in power off status.

7.The DIP switch 4 in the control module is press down, but I still not able to use anti-hijacking function, why?

Please check:

A.If you press down DIP switch 4 on control module in power off status(that's unplug the 6P ignition wire harness from the control module first, then press down DIP switch 4 on control module, then re-plug the 6P ignition wire harness with the control module. If not, please correct the setting.

B. whether the blue/black door trigger wire is well connected, which default setting is negative (-) and can be re-set with jumper on it to be positive (+), for detailed instruction, please refer to note 10 in user manual.

8.How to do programming?

Please refer to programing method in the user manual.

9.How to wire the 3 color (orange, yellow & white) GWR wire?

Please refer to Note 8 in the user manual.

10.How to set the device to valet mode?

Please refer to the valet mode on/off in the user manual.

11.When I open the door, I heard the control module is sound click sometimes, but when I close the door, it's normal, is this a defective product?

No. When you opening the vehicle door, the relay in the control module need to work and will sound click for a few seconds and this is normal. And when you close the door, the clicks will stop accordingly as the relay is not in working status.

12.What's the usage of DIP Switch 6 in the control module?

The switch 6 is for return current. For some vehicles, need to turn the key to ON position first then the foot brake is with electricity when stepping on it. For this kind of cars, need to press down the DIP switch 6. For some types of Volkswagen (VW) cars, even all the wires are correctly connected, but still unable to unlock car doors when press unlock button , if so, please un-plug the 6 pin ignition wire harness from the control module, press down DIP switch 6, then re-plug the 6P ignition wire harness with the control module, now everything is working well now. The switch 6 is mainly for some Volkswagen cars usage.

13.Is there a GWR (ground while running) wire? Or how to connect with a GWR wire to the EC002?

Please refer to note 8 for the GWR wire connection method.

14.How to connect a window closer module with your alarm?

If there is window closer module need to connect with EC002 alarm, please connect the wire from window closer module with white locking wire in central door locking wire.

15.I turn on PKE function then start the car, but when I stop and cut off the engine, the PKE function is automatically turn off and I have to turn it on again, what's the reason?

The problem should due to the blue/black door trigger wire(-) is not well connected.

16.I hook up the door trigger wire, but when opening car door, turn signal light flashes, what's the reason?

If so, please disconnect the door trigger wire first, unplug the 6P ignition wire harness from the control module, then press down DIP switch 2, re-plug the 6P ignition wire harness with the control module.

17.Why there is no orange, white and yellow wire in my kit?

If the alarm is equip with shock sensor, then there is no orange, white and yellow 3 color GWR wire and you can use an extra SPST relay to generate a GWR wire, for detailed instruction, please refer to Note 9 in the user manual.

Warning: This product is intended to be installed by a professional car alarm installer only! Any attempt to install this product by any person but not a trained professional car alarm installer may result in severe damage to the vehicle or the components.

Warranty information

The quality of this product is strictly controlled before out of the factory, which ensure its advanced performance under normal utilization. And we provide 1 year quality guarantee. If there is any failure due to product quality, we will provide free repair or replacement. Any incorrect operation / installation / using lead the product was failed to work is not in cover of free repair or replacement service.

FCC Statement

This equipment has been tested and found to comply with the limits for a Class B digital device, pursuant to part 15 of the FCC rules. These limits are designed to provide reasonable protection against harmful interference in a residential installation. This equipment generates, uses and can radiate radio frequency energy and, if not installed and used in accordance with the instructions, may cause harmful interference to radio communications. However, there is no guarantee that interference will not occur in a particular installation. If this equipment does cause harmful interference to radio or television reception, which can be determined by turning the equipment off and on, the user is encouraged to try to correct the interference by one or more of the following measures:

- Reorient or relocate the receiving antenna.
- Increase the separation between the equipment and receiver.
- Connect the equipment into an outlet on a circuit different from that to which the receiver is connected.
- Consult the dealer or an experienced radio/TV technician for help.

To assure continued compliance, any changes or modifications not expressly approved by the party.

Responsible for compliance could void the user's authority to operate this equipment. (Example- use only shielded interface cables when connecting to computer or peripheral devices).

This equipment complies with Part 15 of the FCC Rules. Operation is subject to the following two conditions:

- (1) This device may not cause harmful interference, and
- (2) This device must accept any interference received, including interference that may cause undesired operation.

RF warning statement:

The device has been evaluated to meet general RF exposure requirement. The device can be used in portable exposure condition without restriction.