

SECTION 5

METER & SERVICE EQUIPMENT

General Rules and Regulations 5-1-1
 Equipment Assembly and Installation 5-1-2
 Indoor Metering, Grounding, and Bonding 5-1-3
 Meter Enclosure Connections 5-1-4
 A-base and B-base Meter Enclosure – Customer Installation 5-1-5
 Bonding and Ground Circuits 5-1-7 and 5-1-8
 Repair and Refastening of Equipment 5-1-9 and 5-1-10

METERS & METER ENCLOSURES

Obtaining Metering Equipment 5-2-1
 Building and Premise Identification 5-2-5 to 5-2-9
 New Service Meter Installation Routine 5-2-1 to 5-2-13
 Application of Watt-hour Meters 5-2-15 and 5-2-16
 Warning Stickers and Safety Checks 5-2-17
 Installation Instructions 5-3-1 to 5-3-3
 Meter Enclosure Specifications 5-3-4

SINGLE PHASE ENCLOSURES

Single-Phase 200A Specifications 5-3-5
 Single-Phase 320A Specifications 5-3-6, 5-3-7, 5-3-7.1 and 5-3-7.2
 Single-Phase 200A 2-position Horizontal Specifications 5-3-8 and 5-3-8.1
 Single-Phase Meter Inspection Checklist 5-3-8.2 to 5-3-8.4

MULTIPLE OCCUPANCY BUILDINGS

Multiple Meter Installation Methods 5-3-9 and 5-3-9.1
 Vertical Meter Stacks 5-3-10 and 5-3-11
 Commercial Metering Switchboard 5-3-12
 Indoor Trough Installation--1Ø 5-3-14 and 5-3-15
 Outdoor Terminal Cabinet Installation--1Ø 5-3-16
 Outdoor Trough Installation--1Ø 5-3-17
 Commercial Metering Switchboard Installation 5-3-26 and 5-3-27

THREE PHASE ENCLOSURES

Poly-Phase 20A and 200A Specifications 5-3-18 to 5-3-19.2
 Outdoor Terminal Cabinet Installation--3Ø 5-3-20
 Outdoor Trough Installation--3Ø 5-3-21
 Indoor Trough Installation--3Ø 5-3-22
 Self-Contained Meter Inspection Checklist--3Ø 5-3-23 to 5-3-25

CURRENT TRANSFORMER CABINETS

Acceptable Cabinets and General Information 5-4-1 and 5-4-2
Current Transformer Ordering Routine 5-4-3
Table of Current Transformer Sizes 5-4-3
Service Change Routine..... 5-4-4
CT Cabinet Fabrication Standards 5-4-5 and 5-4-6
CT Cabinet Installation Standards 5-4-7 and 5-4-8
Service Equipment Assembly (Overhead)..... 5-4-9
Clearance Requirements 5-4-10
Bus Bar Service Details 5-4-11
Service Equipment Assembly 5-4-12 to 5-4-14
CT Cabinet Inspection Checklist 5-4-15 to 5-4-18
Transocket Installations 5-4-19 to 5-4-20
Blade Mount (Window Type) CTs 5-5-1

SWITCHBOARDS

CT Compartment Fabrication Standards 5-6-1 to 5-6-2.1
Meter Enclosure Mounting 5-6-3
Meter Wiring Raceway Installation 5-6-4
Bus Head Drilling Details (Overhead Service)..... 5-6-5
Bus Bar Drilling Details and Dimensions..... 5-6-6 and 5-6-7
Template for Measuring Bus Bar Spacing..... 5-6-8
CT Compartment Door Sealing Details 5-6-9 and 5-6-10
Acceptable Switchboards..... 5-6-11 and 5-6-12
Switchboard Inspection Checklist..... 5-6-13 to 5-6-15

DEMAND RECORDER INSTALLATIONS

Routine for Metal Melting R1.1 and Process Heat R1.2 5-7-1 to 5-7-2
Equipment Assembly Drawings 5-7-4 and 5-7-5

ACCEPTABLE METERING ENCLOSURES AND MODULES

Acceptable Metering Enclosures and Modules..... 5-8-1 to 5-8-17

FAULT CURRENT

Current available to a fault..... 5-9-1

METER AND SERVICE EQUIPMENT**1. General Rules and Regulations.**

- (a) To avoid unnecessary delay or expense, the customer or the customer's representative shall consult the appropriate DTE Electric Service Center *before* starting any wiring. (See pages 1-2-1 through 1-2-4 for Service Center locations.)
- (b) Service equipment assembly drawings showing the space required and the equipment configuration may be obtained from the DTE Electric Service Center upon request.
- (c) The DTE Electric Planner will determine the location of the building service and the meter equipment.
- (d) The customer's service equipment must be installed and maintained according to the rules of the inspection authority having jurisdiction. The rules of the Company are in addition to and not a waiver of the rules of the inspection authority. In areas where there is no inspection authority, the wiring installation must comply with the requirements of the *National Electrical Code* and any Electrical Rules supplementary thereto. An outdoor disconnect is required for one- and two-family dwellings in compliance with 2023 NEC N230.85, emergency disconnects must be grouped and installed on the load side of the utility meter(s).
- (e) The Company reserves the right to inspect customer's wiring to ensure that safe methods of construction have been followed. By performing such an inspection, the Company does not assume responsibility for performance of the installation.
- (f) Covers of all enclosures such as wireways, pull boxes, and switch or circuit breaker cabinets containing conductors carrying unmetered current shall be equipped with DTE Electric approved sealing devices.
- (g) Wires carrying metered and unmetered current shall not occupy the same raceway, cable assembly, fitting box, or other enclosure.
- (h) Customers or contractors are not authorized to break seals to open or move meter connection cabinets without obtaining permission from an authorized representative of the Company.
- (i) The customer's service equipment and meter enclosure(s) must **not** be located under an operable window.
- (j) The installation of customer owned equipment, including current coils and/or voltage monitoring, on or around unmetered conductors or within the DTE sealed section of service equipment is strictly prohibited.

2. Customer's Installation.

- (a) Service entrance wiring consists of all the wiring from the service connection to and including the meter equipment and service disconnecting and overcurrent protective means. This equipment shall be installed in accordance with applicable laws and the rules of the governmental authority having jurisdiction, the *National Electrical Code*, and the rules of the Company.
- (b) The customer shall provide, at a location approved by the Company and free of expense to the Company, a suitable place for the meter or meters and any other supply, protective, or control equipment of the Company which may be required in the delivery of the service.

3. Multiple Service Entrance Conductors--Overhead.

Refer to Overhead Service Installation Section 4, page 4-4-4.

4. Multiple Service Entrance Conductors--Underground.

Refer to Underground Service Installation Section 3, page 3-3-1.

5. Identification of Service Entrance Conductors.

Refer to Overhead Service Installation Section 4, page 4-4-4.

6. Service Equipment Assembly.

- (a) The DTE Electric Service Center will furnish service equipment assembly diagrams indicating the space required and the manner in which the equipment is to be assembled.
- (b) The location of the service and metering equipment will vary with the conditions peculiar to each installation. Therefore, the DTE Electric Planner will determine the assembly and location of all such equipment.

7. Service Equipment Installation.

- (a) When a new commercial building or when adding load to an existing building is planned, it is important that the customer or his architect submit drawings to the DTE Electric Service Center ***before* construction begins**. This will allow the Company to determine the size and location of the service and metering equipment and to issue the necessary orders in advance of the customer's need date.
- (b) In instances where, at a later date, a new commercial building could be subdivided into multiple units, the design of the electric service should provide for ease of conversion to separate metering of each unit.

- (c) Service and metering equipment shall be installed in accordance with the service equipment assembly diagrams assigned to each installation by the DTE Electric Planner.
- (d) Metering equipment shall not be used as a raceway or service terminal to feed other meter enclosures except as shown on service equipment assembly drawings.

8. Meters for Residential and Commercial Services.

In general, meters for residential and commercial services will be installed outdoors. If possible, meters will be located directly below the service point on overhead services and directly above the service point on underground services. The DTE Electric Planner must approve any deviations.

9. Indoor Metering.

- (a) Indoor metering **must be approved** by a DTE Electric Planner.
- (b) Indoor metering equipment will be located as near as possible to the service entrance, in a clean dry place, reasonably secure from injury, not subject to vibration and readily accessible for reading and testing.
- (c) In multiple occupancy buildings, where the meters are installed indoors, they shall be located within the premises or in a common location accessible to the tenants and to DTE Electric representatives.
- (d) At the discretion of the Company, meter rooms may be required in buildings where more than four meters are grouped in one location. The room is to be accessible at all times to authorized representatives of DTE Electric and to customers. The Company requires this room to be not less than 4 feet wide to protect its equipment.

10. Grounding and Bonding of Service Equipment.

- (a) The service neutral and the equipment supplying lighting and power shall be grounded at the customer's lighting switch unless grounding provisions at that point are inadequate.
- (b) When such exceptions are encountered, the grounding conductor may be terminated at the neutral bus of a current transformer cabinet. A lug of correct capacity will be added to a pass-thru bolt and will allow the customer to connect on the outside of the CT cabinet. On the inside, it will be connected to one of the bolts that secure the neutral bus to the back of the cabinet.
- (c) A DTE Electric representative will check such grounding connections for proper installation.
- (d) The customer will supply insulated neutrals where required by *National Electrical Code* for those installations where the meters are on the load side of the customer's main disconnect and main bonding jumper. See 2023 NEC 250.142 (B) for exceptions.

JUL 2024

- (e) Any bond between the meter enclosure and joint users that interferes with removing the cover on the meter box is a violation of NEC 250.94 (A)(3). The joint user who created the violation must correct the situation.

11. Meter Enclosure Connections.

- (a) An additional service disconnect will be connected in series and in close physical proximity to the additional meter enclosure when required for separately metered water heater or space conditioner circuits. Unless authorized by *local electrical code*, **each service drop or lateral** shall be wired through a single set of disconnects. (See SIM-ESIG 3-3-1, (1), (a) and 4-4-1 (j), (k) prior to construction.) *120-volt circuit shall not be connected in a meter enclosure. -No Exceptions.*
- (b) A meter that serves a remote building with overhead or underground conductors shall have a service disconnect grouped with the service main disconnect or within the main panel. This provides overcurrent protection and allows the customer to safely disconnect these service conductors in the event of contact or damage. Otherwise, DTE Electric would have to respond to any emergency to disconnect the customer-owned conductors and remove any hazards.

Customer's Installation: A-base or B-base Meter Enclosure

1. When a repair or upgrade to a customer's installation requires replacement of the service entrance conductors, or an addition to the existing conductors, the customer/contractor will:
 - Contact the area Service Planner to assess the existing meter equipment.
 - Replace the existing A-base or B-base Meter Enclosure.

NOTE: Under no circumstance will an existing A-base or B-base Meter Enclosure have the service entrance wiring replaced, modified, or added to.

BONDING AND GROUND CIRCUITS

The primary purpose of bonding and ground circuits is to provide a permanent low impedance conductive path back to the source of electrical supply so that maximum possible ground-fault current will go through the **Over Current Protective Devices (OCPD)**. If the conductive bodies become energized, it will cause the **OCPD** to quickly open all ungrounded phase conductors and limit the voltage to ground (See NEC 250).

When making electrical connection to bonding and ground circuits any grease, corrosion, non-conductive paint, enamel, or similar coating that will impede electrical conductivity shall be removed at threads, contact points, and contact surfaces (See NEC 250.96 (A)).

On alternating current (AC) systems with more than two wires, the neutral conductor carries the unbalanced load current back to the source of supply. On two wire systems, the neutral carries all return current. This conductor must be continuously insulated with a white, gray, or white striped jacket. It must be routed with the phase conductors. It must be contained in the same raceway and bonded to each service disconnecting means. (See NEC 250.24 (C), (D), 300.3) In most cases it will be sized the same as the phase conductors. It shall be connected to the bonding and ground electrode system at only one point. This will prevent multiple current paths back through ground. Overhead lines service drops do not need to have an insulated neutral. This conductor can serve as the bonding conductor on service equipment. (See NEC 250.92 (B)(1), 250.142 (A))

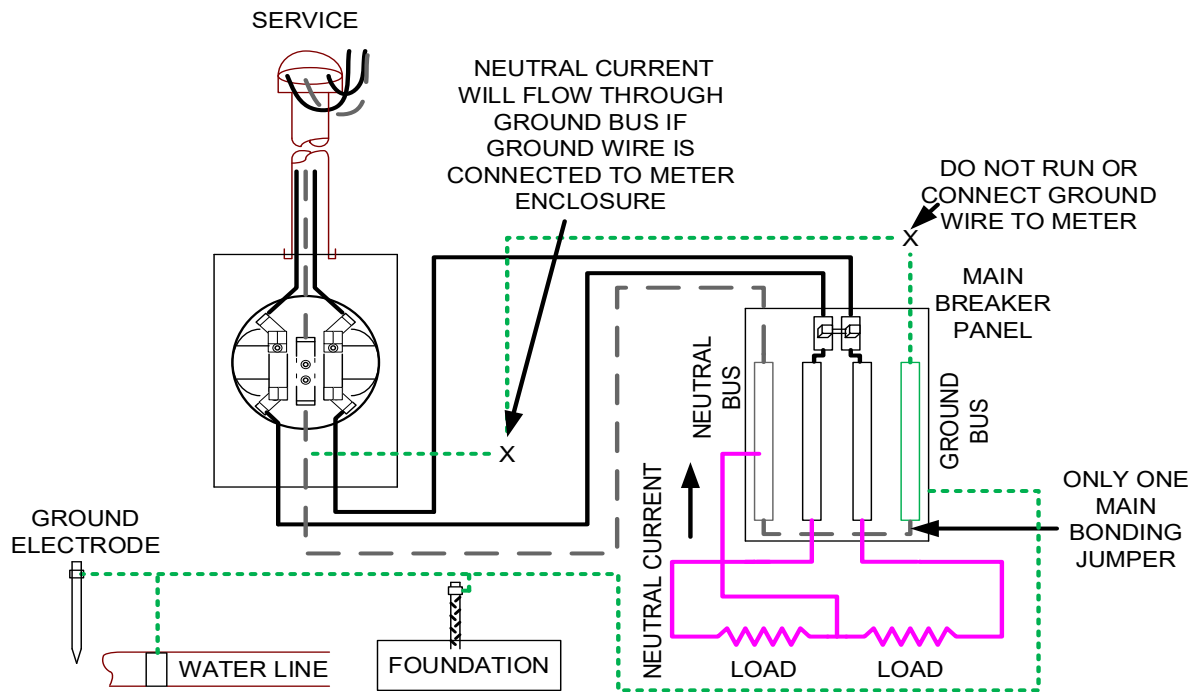

SEE 2023 NEC 250.52 GROUNDING ELECTRODES AND 250.66 GROUNDING ELECTRODE CONDUCTOR FOR ALTERNATING CURRENT SYSTEMS

NEUTRAL CURRENT WILL FLOW THROUGH THE GROUND CIRCUIT IF THERE IS MORE THAN ONE MAIN BONDING JUMPER OR PARALLEL PATH FOR NEUTRAL BACK TO THE METER ENCLOSURE.

ANY BOND BETWEEN THE METER ENCLOSURE AND JOINT USERS THAT INTERFERES WITH REMOVING THE COVER ON THE METER BOX IS A VIOLATION OF NEC 250.94 (A)(3). THE JOINT USER WHO CREATED THE VIOLATION MUST CORRECT THE SITUATION.

SERVICE WITH METER ENCLOSURE AND SEPARATE OUTDOOR DISCONNECT

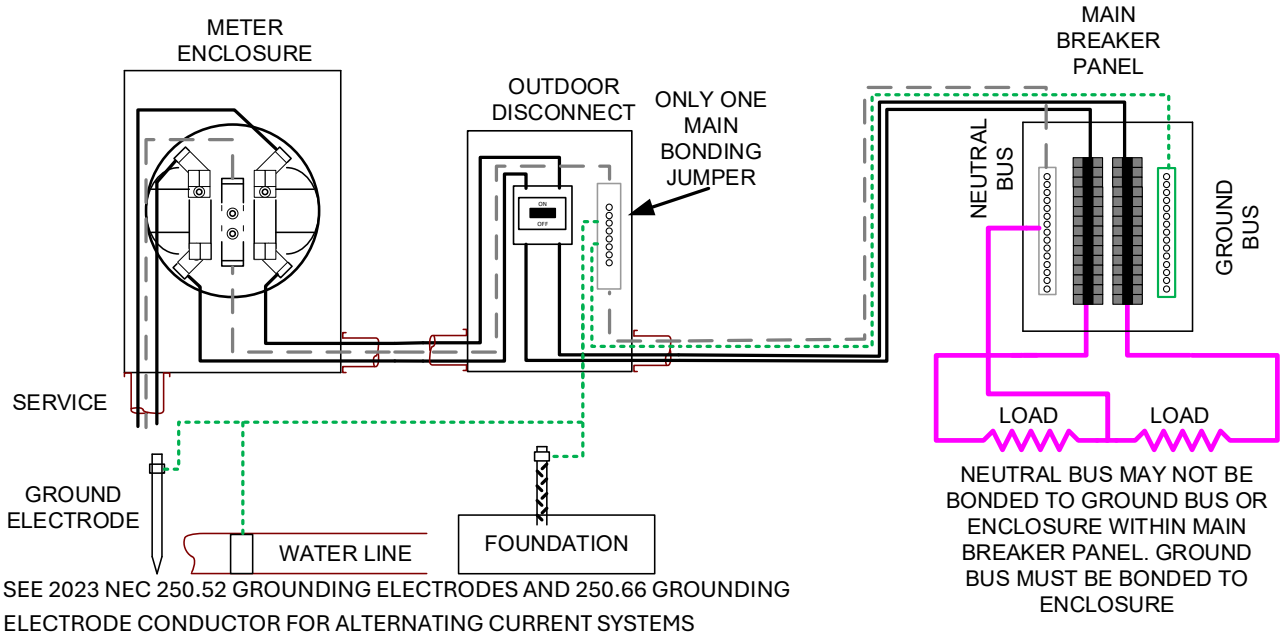

SERVICE WITH METER MAIN OR LOAD CENTER COMBO

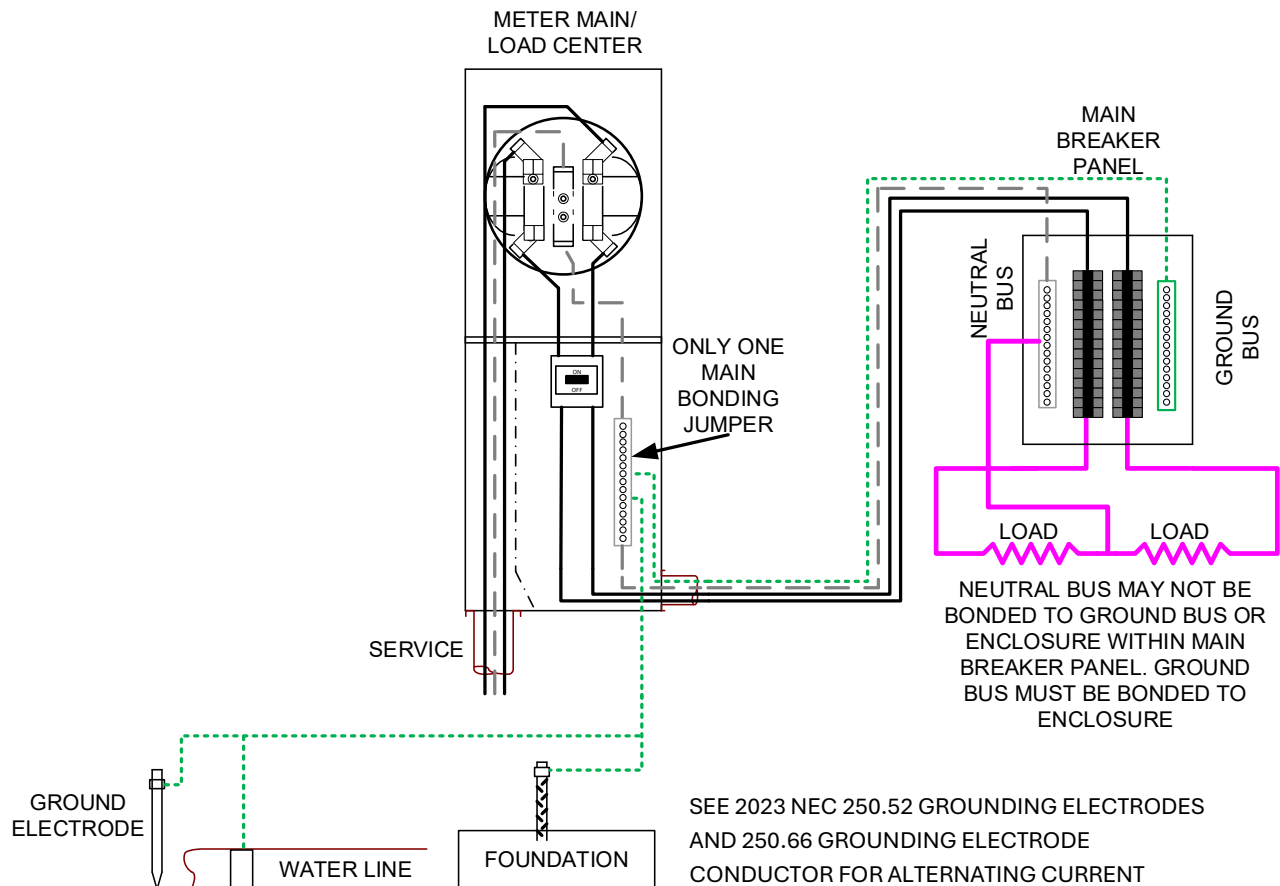

BONDING AND GROUND CIRCUITS (cont'd)

An AC service configuration that does not include a ground or neutral conductor back to the utility source of electrical supply is not allowed. This neutral conductor shall be sized so that it can safely conduct maximum ground-fault current back to the source of electrical supply. This conductor shall be brought to the service main enclosure. The main bonding jumper shall be located in the service mains enclosure. Equipment grounding conductors and the main bonding jumper shall not be brought into the metering enclosure. If another means of grounding is installed, than the neutral shall be insulated.

An AC service shall have only one main bonding jumper. The main bonding jumper is the single point at which bonding and the grounding electrode system is connected to the source of electrical supplies' neutral or return conductor. Use of multiple bonding between neutral and the grounding electrode conductor, which ties to earth, will result in a parallel return current flowing through the building and earth. This could result in many unusual problems. Hot locknuts connected to boxes have arced away metal. This arcing can leave a hole in the box. Metal trim has been observed glowing red from this problem.

The grounding electrode system of a structure supplied from another structures service drop can be tied to the neutral or return conductor if at the time of being built a separate equipment grounding conductor was not required to be run with the feeder or branch circuit. (See 2023 NEC 250.32 (B)(1)) If an equipment ground conductor of an existing appliance was not required in the past to be run with a feeder or branch circuit, then the equipment frame can be grounded by the neutral or return wire. (See 2023 NEC 250.32, 250.140). A meter enclosure on the load side of the service disconnect can be grounded by neutral or the return conductor if all the following applies: 1) No ground fault protection at the service; 2) All meter enclosures are located next to the main disconnect; 3) the neutral or return conductor is sized properly. Otherwise a load side meter enclosure must have its neutral isolated from ground. (See 2023 NEC 250.142 B)

Equipment grounding conductors, grounding electrode conductors, and bonding jumpers shall be connected by one of the means listed in 2023 NEC 250.8(A). Connection devices or fittings that depend solely on solder shall not be used. (See 2023 NEC 250.8(B).)

Method of Bonding at the Service

Bonding jumpers shall be used around impaired connections such as reducing washers or knockouts in order to achieve required bonding. See 2023 NEC 250.92 for detail on what needs to be bonded and allowed methods of bonding.

Bonding for Over 250 Volts (Non-Service)

Bonding for non-service circuits over 250 Volts to ground has special requirements. Note that the requirements are different depending on whether knockouts are involved and depends on if the knockouts are listed to provide a reliable bonding connection. See 2023 NEC 250.97 for detail on allowed methods of bonding.

Bonding for Communication systems

See 2023 NEC 250.94 for Bonding for Communication systems.

SEPARATE METERED RATES IN MULTIPLE SERVICE BUILDINGS

Town houses and some multiple occupancy buildings typically have more than one service entrance point. *Code* allows for up to six sets of service disconnecting means off of one service drop. These must be grouped. These separate services must individually feed separate occupancy spaces, apartments or suites. It is a violation of good wiring practice to extend a separate metered service form one service point into an area served by another service entrance. The exception to this is a dedicated circuit on a different rate schedule. One example of this is an electric water heater circuit run into a building serviced by a single residential or general service. Another example is in a multiple occupancy building's house meters that the building owner uses to furnish energy for the tenant's electric space heat. Care shall be taken not to inter-mix wiring on the load side of these services. Wiring from one service main in one part of the building shall not connect circuits to another service main. If a ground from one service is tied to another service an objectionable passage of ground-fault current over a grounding conductor could result. There could be other detrimental effects from this inter-mixing of wiring.

The owner of a multiple occupancy building may want one account with a separate meter for each service entrance. As an unavoidable result, the number of units billed will now be split through more than one meter, increasing the units billed at initial step rates. From a billing standpoint, this is correct because buildings with multiple service entrance points, for all practical purposes, are separate buildings joined by a common fire wall. Town houses are continuous constructed single dwellings.

REPAIRS TO CUSTOMER SERVICE ENTRANCE EQUIPMENT

The DTE Electric Company will only make temporary repairs to customer-owned service entrance equipment. These repairs may include the installation of a multiple arc or a temporary service.

When either of the two methods are used and the trouble is definitely determined to be in the customer's service entrance equipment, the defective equipment will be yellow tagged and the customer will be advised, in writing, that the multiple or temporary service will be removed in fifteen days. The customer must engage a contractor, at his expense, to make permanent repairs.

All costs of permanent repairs are to be borne by the customer.

REFASTENING EQUIPMENT AFTER INSTALLATION OF SIDING

Siding installation contractors usually find it necessary to loosen the meter enclosure, service cable or conduit, and service attachment when installing siding on existing residences. At the request of the contractor, the Company will loosen the meter enclosure and, if necessary, remove the service drop from the building. The contractor is responsible for unfastening and refastening the service entrance cable or conduit. Electric Field Operation Personnel will loosen and reinstall the meter enclosure.

REFASTENING EQUIPMENT AFTER INSTALLATION OF SIDING - cont'd

If it is necessary to have the service drop removed from the building, Service Planning or Customer Service will arrange to have the contractor locate the attachment point. The contractor must locate the stud.

METERING ENCLOSURES

DTE Electric has adopted the electrical industry standard for meter enclosures.

It is the customer's responsibility to provide and install a DTE Electric approved meter enclosure listed in subsection 5-8.

INSTALLATION INSTRUCTIONS
METER ENCLOSURES

1. Service entrance wires that will connect to an overhead service drop shall enter the meter enclosure only through the hub provided at the top of the cabinet. A watertight box connector shall be used at the service hub when service entrance cable is used. All outdoor meter enclosures must be weatherproof (NEMA Type 3R).
2. Underground service conductors must enter through the bottom of the meter enclosure. Conduit entering the ground shall be rigid or intermediate metal conduit or *electrical* rigid Polyvinyl Chloride (PVC) Schedule 80, or equivalent, nonmetallic rigid conduit suitable for the location. (See NEC 305.15 (C), *Underground Installations*) (See page 3-4-1, 3-4-3.1 & 3-4-3.2).
3. Load wires shall enter the enclosure below the load terminals. Entry may be made through the sides, bottom, or back. (See NEC 338.24, *Bending Radius*, “The radius of the curve of the inner edge of any bend, during or after installation, shall not be less than five times the diameter of the cable.”) No more than one connection may be made on the load side for CL 200 installations or no more than two connections on CL 320 installations. Additional connections must be made in a separate junction box.
4. Conductors shall be positioned in the enclosure to provide proper clearance for installation of the meter. Connectors for more than one conductor and connectors used to connect aluminum conductors must be listed and approved for the purpose. Inhibitor of the non-grit type must be used on all aluminum conductors (sparingly). There shall not be more than one conductor under one pressure device (set screw, pad, and so on) unless designed for connecting multiple conductors. All conductor strands shall be contained beneath the connector pressure device. All connectors will be tightened to their proper torque value.
5. Meter enclosures shall be **located outdoors** unless otherwise authorized by a DTE Electric Planner.
6. Meter enclosures shall be securely fastened to the wall without distortion using one of the following methods:
 - (a) Masonry: Appropriate anchors or toggle bolts with galvanized screws.
 - (b) Wood Framing: Galvanized wood screws with a 3/4-inch plywood or pine backing. *Nailing into wood is not acceptable*. This applies to a building that is primarily wood frame construction. This does not apply to a temporary service installation. Consult Meter Engineering for other means acceptable to DTE Electric.
7. The customer shall install only meter enclosures **approved** by DTE Electric and listed in section 5-8.

JUL 2024

8. Meter enclosures shall be surface mounted on the outside wall of the building. *Enclosures shall not be concealed or recessed into building walls.*
9. To ensure accurate meter registration, meter enclosures must be mounted with the sides and face vertically plumb.
10. Do **not** route the service entrance grounding electrode conductor through or terminate it in the meter enclosure. Note that most UL listed meter enclosures have a grounding terminal that takes a #8 AWG copper conductor in conjunction with a small bottom knock out. This is used for bonding sub-metering enclosures. **Do not use this terminal or knock out.** See UL 414, Section 11.
11. Any bond between the meter enclosure and joint users that interferes with removing the cover on the meter box is a violation of NEC 250.94 (3). The joint user who created the violation must correct the situation.
12. If the supply source is 120/208 WYE, Customer shall furnish and install a grounded fifth terminal mounted in the (9 o'clock position) in each socket.
13. Where approved, insulated neutral terminals will be supplied and installed by the **Customer.**
14. Single Meter Installations

The following vertical clearances shall be maintained:
 - (a) Maximum 6'-0" from top of meter enclosure to floor or final grade.
 - (b) Minimum 3'-6" from center of meter face to floor or final grade.
15. Minimum 1-ft horizontal clearance required from enclosure to inside corner of building. (See page 5-4-10.)
16. Minimum 3-ft working space depth required in front of meter enclosure. This area must be clear of obstacles such as trees and permanently installed equipment such as air conditioning condensing units so that maintenance and testing can be performed. (See page 5-4-10.)
17. Minimum 30-in wide working space required in front of meter (equipment) or width of equipment, whichever is greater. At all times, all hinged equipment doors must be capable of opening more than 90 degrees. (See NEC 110.26 (A)(2), *Width of working Space.*) (See page 5-4-10.)
18. Minimum 24-in wide and from ground level to 6-1/2 ft high access and entrance space to meter required.

19. **Demand** loads higher than the following must have the meter installation design or installation converted to a CT-rated enclosure with a CT cabinet:

- (a) **SINGLE PHASE (240V)** demand loads **are limited to** 320 amperes continuous for commercial and residential services. Demand loads over 200 through 320 amperes continuous will use a class 320 meter enclosure.
- (b) **SINGLE PHASE NETWORK (120/208V)** demand loads **are limited to** 200 amperes continuous for commercial and residential services.
- (c) **POLYPHASE** demand loads can not exceed 200 amperes continuous.

Note*: NFPA 70 defines a continuous load as; “A load where the maximum current is expected to continue for 3 hours or more.” Computation of continuous load; “The sum of the noncontinuous loads plus 125 percent of continuous loads.” See 2023 NEC 100, “Continuous Load”, 2023 NEC 230, “Services”, IV. “Service Entrance Conductors”, and 2023 NEC 230.42 (A)(1), for amp rating of main breaker

Design or convert to current transformer service if service size is over these limits:

Service Rating in Amperes	Meter Class	Continuous Demand Rating in Amperes	Service Type
320	320	320	Single (240V)
200	200	200	Poly & Network

- 20. All 240/480 Volt single-phase services using a self-contained meter must use a single phase four terminal enclosure with lever bypass and jaw release.
- 21. The DTE Planner in the particular area involved must be contacted for prior acceptance of any variances to the above specifications **before work begins.**
- 22. A temporary service installation must use angle iron, beeline or unistrut as a supporting structure for all meters and equipment. Wood shall not used as support in place of angle iron, beeline or unistrut for a temporary or permanent service. On a temporary service wood posts can be used for the vertical support of the metal frame that is used to support service equipment. All wood posts must be properly treated for their use and stabilized by concrete. Rigid steel posts must be hot dipped galvanized and stabilized by concrete. See Section 3 for Underground Service Installations or Section 4 for Overhead Service Installations. See 2023 NEC, 590.4, Temporary Installations; General, (A) Services. “Services shall be installed in conformance with Article 230.”

The DTE assumes no responsibility for injury or damage arising from the use of these specifications.

SEPT 2018

Meter Enclosure Specifications

METER ENCLOSURE	1Ø, CL200 OH	1Ø, CL200, UG	1Ø, CL200, UG/OH <u>Note 8</u>	1Ø, CL320, UG/OH	1Ø, CL20, CT	3Ø, CL20, CT	3Ø, CL200 UG	3Ø, CL200 OH	1Ø, CL100 <u>Note 9</u>
OBSOLETE TERMINOLOGY	ZS-200 ZS-200Y	ZSU-200 ZSU-200Y	ZS-200	ZSU-320	ZS3-20-5S	ZS3-20-9S	ZS3-200P	ZS3-200H	ZSW-100
ELECTRIC METER ENCLOSURES AND ACCESSORIES (List from 5-8-13)	1 Phase, Ringless, 4 Terminals <u>Note 7</u>	1 Phase, Ringless, 4 Terminals <u>Note 7</u>	1 Phase, Ringless, 4 Terminals, With Lever Bypass and Jaw Release	1 Phase, Ringless, 4 Terminals, With Lever Bypass and Jaw Release	1 Phase, CT Rated, Ringless, with Test Switch	3 Phase, CT Rated, Ringless, with Test Switch	3 Phase, Self Contained, 7 terminals, With Bypass Lever <u>Note 7</u>	3 Phase, Self Contained, 7 terminals, With Bypass Lever <u>Note 7</u>	1 Phase, 4 Terminals
WIRE SIZE	#10 THRU 250 KCMIL	#2 THRU 250 KCMIL	#2 THRU 250 KCMIL	<u>Note 6</u>	10-pole test switch	10-pole test switch	#2 THRU 250 KCMIL	#2 THRU 250 KCMIL	#10 THRU 1/0
HUB SIZE	2"	NONE	2"	NONE	NONE	NONE	NONE	2-1/2"	NONE
KO SIZE	¾" THRU 2-1/2"	¾" THRU 2-1/2"	¾" THRU 2-1/2"	2" THRU 3"	<u>Note 4</u>	<u>Note 4</u>	<u>Note 4</u>	<u>Note 4</u>	¾" THRU 1-1/2"
COMMON SIZE <u>Note 5</u>	9" x 16" x 5"	11" x 16" x 5"	8" x 13" x 19"	13" x 22" x 5"	14" x 16" x 3-1/2"	14" x 16" x 3-1/2"	13" x 19" x 5"	10" x 19" x 5"	8" x 11" x 4"
RATED AMPERES(A)	200	200	200	320	20	20	200	200	100
MAX SERVICE AMPERES(A)	200	200	200	200 TO 320	>320	>200	200	200	100
VOLTAGE(V)	120/240 120/208Y <u>Note 1</u>	120/240 120/208Y <u>Note 1</u>	240/480	120/240	120/240 240/480	<u>Note 3</u>	<u>Note 3</u>	<u>Note 3</u>	240 P-P <u>Note 2</u>
BY PASS	NONE	NONE	LEVER BY PASS AND JAW RELEASE	LEVER BY PASS AND JAW RELEASE	NONE	NONE	LEVER BY PASS AND JAW RELEASE	LEVER BY PASS AND JAW RELEASE	NONE
SERVICE INSTALL REFERENCES	SECTION 4	SECTION 3	SECTION 3 & 4	SECTION 3	SECTION 3 & 4	SECTION 3 & 4	SECTION 3	SECTION 4	SECTION 7
DRAWINGS	5-3-5	5-3-5	5-3-5	5-3-6 THRU 5-3-7.2	5-3-19.1	5-3-19.1	5-3-18 5-3-19	5-3-18 5-3-19	VARIOUS

Note 1: If the supply source is 120/208 WYE, **Customer** shall furnish and install a grounded fifth terminal mounted in the 9 o'clock position in each socket.

Note 2: P-P is phase to phase voltage, all others phase to ground and phase to phase.

Note 3: 3phW Wye, 120/208V or 277/480V also 3phW Delta, Grounded 120V, 240V or 480V also 3phW Delta, 240V

Note 4: All KO's located below the line of the lowest live part. See UL 414, 4.2.3

Note 5: Width x Length x Depth, Enclosure can have larger dimensions.

Note 6: Terminals are 3/8" studs with captive "Belleville" washer nuts. Must have one 10-32 tapped hole in each line bus.

Note 7: OH/UG type enclosure can substitute for the UG or OH enclosure. OH/UG will be larger than an OH type.

Note 8: Also used for 3Ø, 3W Delta, 120-480V.

Note 9: To be used only for Air Conditioning/Heating/Cooling/Plug-in vehicles rates or for maintenance of existing 100A service

The DTE Energy Company assumes no responsibility for injury or damage arising from the use of these specifications.

SINGLE PHASE METER ENCLOSURES

OVERHEAD

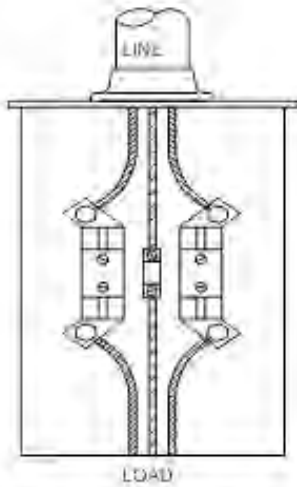

10, CL200, 3W, 120/240V

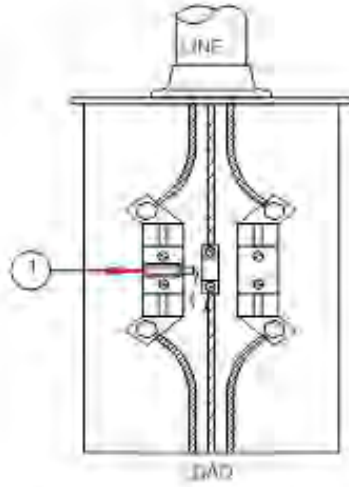

Network, CL200, 3W, 120/208V

LEGEND (1) POTENTIAL JAW FOR 120/208 VOLT SERVICE

UNDERGROUND

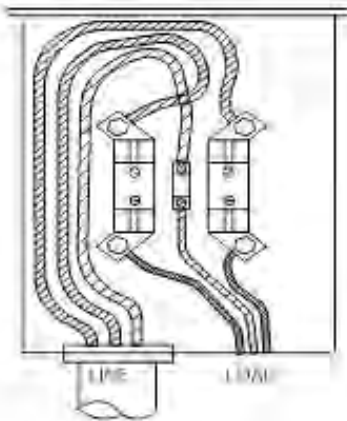

10, CL200, 3W, 120/240V

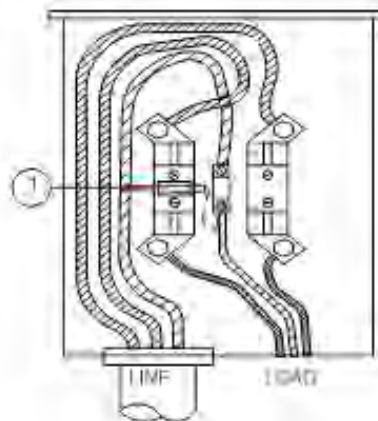

Network, CL200, 3W, 120/208V

DTE ELECTRIC COMPANY ASSUMES NO RESPONSIBILITY FOR INJURY OR DAMAGE ARISING FROM THE USE OF THIS SPECIFICATION DIAGRAM.

SINGLE PHASE METER MAIN OR LOAD CENTER ENCLOSURES

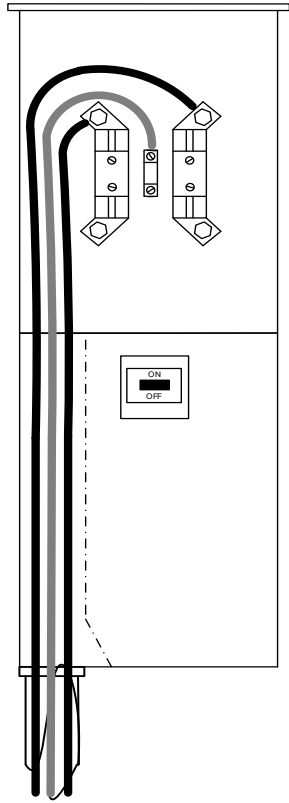

1Ø, CL200, 3W, 120/240V

POTENTIAL JAW FOR
120/208V SERVICE

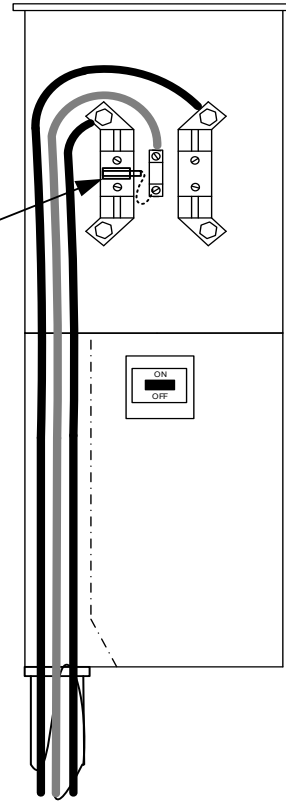

Network, CL200, 3W, 120/208V

NOTES:

1. AN EXPANSION JOINT IS REQUIRED ON INCOMING SERVICE CONDUIT TO ACCOMMODATE THERMAL EXPANSION AND PREVENT DAMAGE TO SERVICE CONDUCTORS AND TERMINALS..

DTE ELECTRIC ASSUMES NO RESPONSIBILITY FOR INJURY OR DAMAGE
ARISING FROM THE USE OF THIS SPECIFICATION DIAGRAM

1 Φ , 3W, CL320, 120/240V METER ENCLOSURE
UNDERGROUND APPLICATION

1-9-226

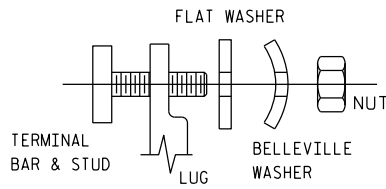

TERMINAL ASSEMBLY

INSTALL RIGID STEEL
CONDUIT NIPPLE WITH
SEALING LOCKNUTS
1-1/2" FROM BOTTOM

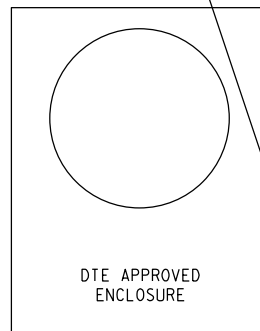

NON-METALLIC BUSHING REQUIRED

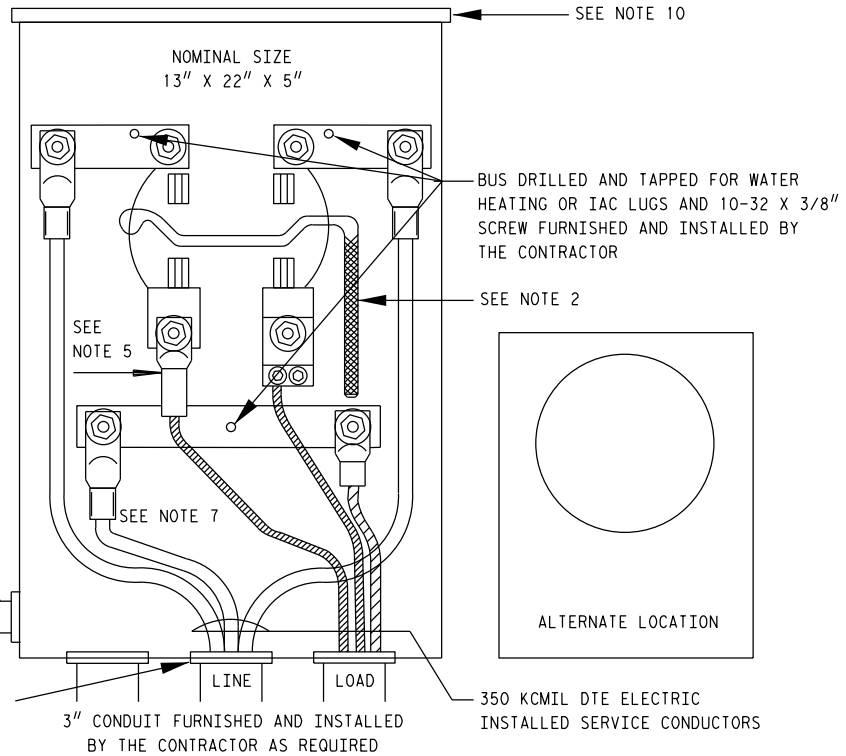

NOTES:

1. NO ENTRY IS TO BE MADE THROUGH THE TOP OF THE ENCLOSURE.
2. THE BYPASS HANDLE MUST BE RAISED TO THE UP OR OPEN POSITION BEFORE INSTALLING OR REMOVING THE METER.

CAUTION: IN THE UP POSITION THE LINE AND LOAD SOCKET JAWS ARE BRIDGED AND THEREFORE THE LOAD SIDE OF THE METER IS ENERGIZED.
3. NEVER USE THE BYPASS AS A JUMPERING DEVICE IN LIEU OF A METER. NEVER INSTALL OR REMOVE THE METER WITHOUT DISCONNECTING ALL OF THE CUSTOMER'S LOAD.
4. THE CLEAR PLASTIC SHIELD IS TO GUIDE THE METER BLADES SAFELY INTO THE JAWS OF THE ENCLOSURE AND SHALL NEVER BE REMOVED.
5. CAUTION MUST BE OBSERVED TO ENSURE THAT THE LOAD CONNECTORS CANNOT ROTATE AND ACCIDENTALLY CONTACT THE NEUTRAL STUD.
6. SEE 1-9-229.2 (SIM-ESIG 3-4-3.2) FOR UNDERGROUND SERVICE INSTALLATION DETAILS REGARDING THIS ENCLOSURE.
7. LOAD LUGS FURNISHED AND INSTALLED BY THE CONTRACTOR. IF MORE THAN ONE CONDUCTOR IS TO BE INSTALLED PER PHASE, A UL LISTED LUG AS SUITABLE FOR MULTIPLE CONDUCTORS OR TWO SINGLE CONDUCTOR LUGS INSTALLED BACK-TO-BACK SHALL BE USED. NO MORE THAN TWO CONNECTIONS CAN BE MADE ON THE LOAD SIDE. ADDITIONAL CONNECTIONS SHALL BE MADE IN A SEPARATE JUNCTION BOX.
8. THE USE OF THIS ENCLOSURE IS EXPRESSLY PROHIBITED FOR ANY APPLICATION WHERE THE CONNECTED LOAD IS LESS THAN 200 AMPS OR THE DEMAND LOAD IS GREATER THAN 320 AMPS. FURTHERMORE, IT SHALL NOT BE USED FOR ANY COMMERCIAL SERVICE THAT MAY HAVE FUTURE NEED TO INCREASE LOAD OR CHANGE TO THREE PHASE.
9. WHENEVER THIS ENCLOSURE IS USED, THE DTE ELECTRIC PLANNER MUST ARRANGE TO HAVE A CLASS 320 S-BASE METER INSTALLED IN IT.
10. ANY BOND BETWEEN THE METER ENCLOSURE AND JOINT USERS THAT INTERFERES WITH REMOVING THE COVER ON THE METER BOX IS A VIOLATION OF NEC 250.94 (A)(3). THE JOINT USER WHO CREATED THE VIOLATION MUST CORRECT THE SITUATION.

DTE ELECTRIC COMPANY ASSUMES NO RESPONSIBILITY FOR INJURY OR DAMAGE ARISING FROM THE USE OF THIS SPECIFICATION DIAGRAM.

1Ø, 3W, CL320, 120/240V SINGLE PHASE METER MAIN OR LOAD CENTER ENCLOSURES

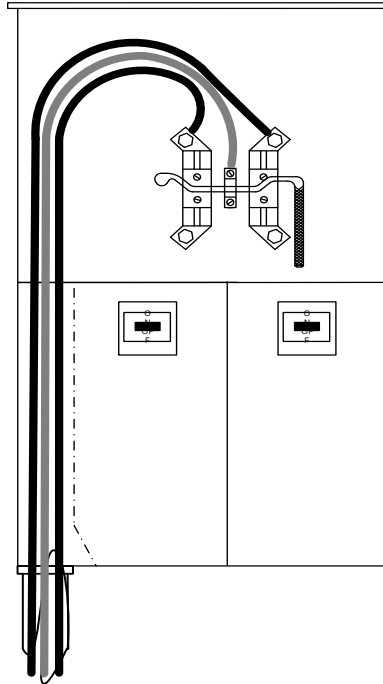

NOTES:

1. AN EXPANSION JOINT IS REQUIRED ON INCOMING SERVICE CONDUIT TO ACCOMMODATE THERMAL EXPANSION AND PREVENT DAMAGE TO SERVICE CONDUCTORS AND TERMINALS..
2. NO ENTRY IS TO BE MADE THROUGH THE TOP OF THE ENCLOSURE.
3. THE BYPASS HANDLE MUST BE RAISED TO THE UP OR OPEN POSITION BEFORE INSTALLING OR REMOVING THE METER.

CAUTION: IN THE UP POSITION THE LINE AND LOAD SOCKET JAWS ARE BRIDGED AND THEREFORE THE LOAD SIDE OF THE METER SOCKET IS ENERGIZED.

4. THE USE OF THIS ENCLOSURE IS EXPRESSLY PROHIBITED FOR ANY APPLICATION WHERE THE CONNECTED LOAD IS LESS THAN 200 AMPS OR THE DEMAND LOAD IS GREATER THAN 320 AMPS . FURTHERMORE, IT SHALL NOT BE USED FOR ANY COMMERCIAL SERVICE THAT MAY HAVE FUTURE NEED TO INCREASE LOAD OR CHANGE TO THREE PHASE.
5. WHENEVER THIS ENCLOSURE IS USED, THE DTE SERVICE PLANNER MUST ARRANGE TO HAVE A CLASS 320 S-BASE METER INSTALLED IN IT.
6. ANY BOND BETWEEN THE METER ENCLOSURE AND JOINT USERS THAT INTERFERES WITH REMOVING THE COVER ON THE METER BOX IS A VIOLATION OF NEC 250.94 (A)(3). THE JOINT USER WHO CREATED THE VIOLATION MUST CORRECT THE SITUATION.
7. SEE SIM 3-4-3.2 FOR UNDERGROUND SERVICE INSTALLATION DETAILS REGARDING CLASS 320 ENCLOSURES.

DTE ELECTRIC ASSUMES NO RESPONSIBILITY FOR INJURY OR DAMAGE
ARISING FROM THE USE OF THIS SPECIFICATION DIAGRAM

1Ø, CL320, 3W, 120/240V METER ENCLOSURE

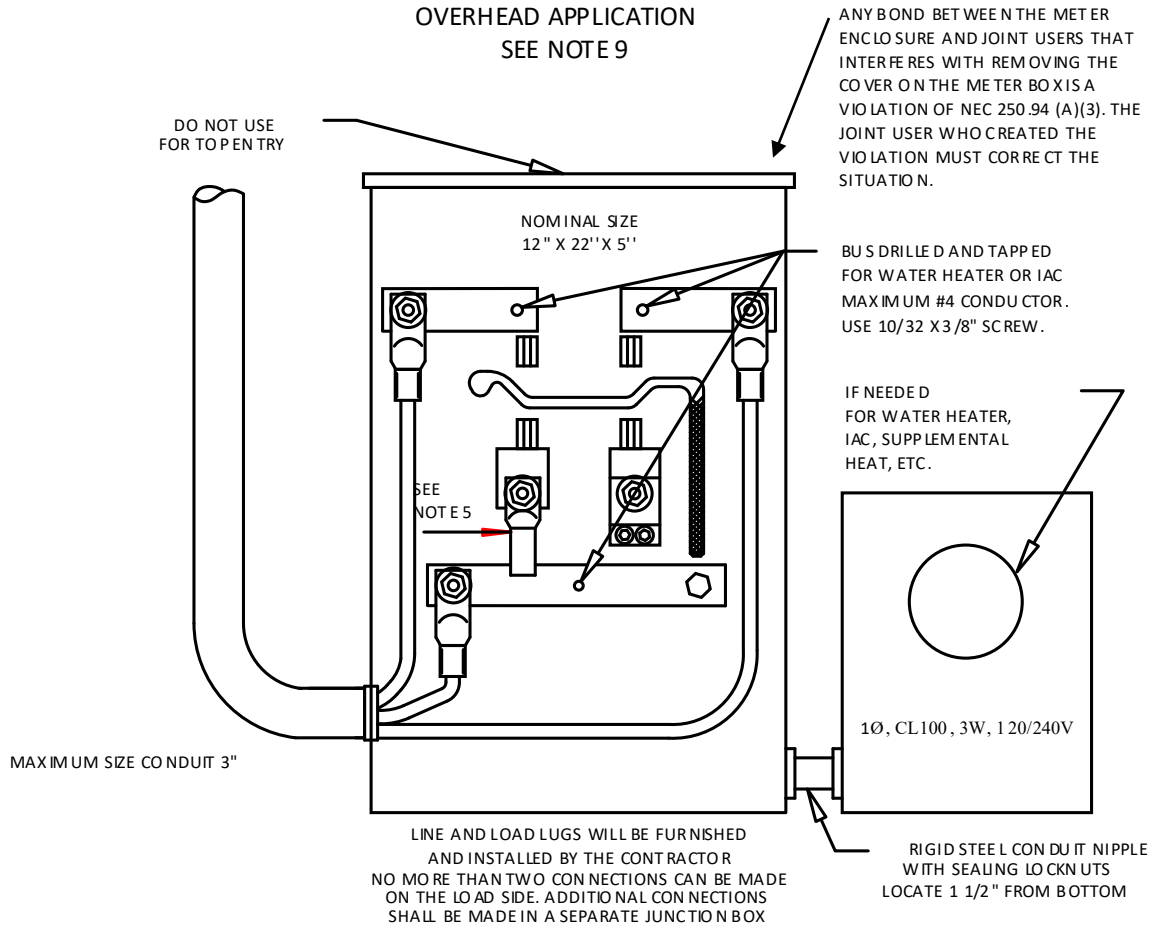

NOTES:

1. THE BYPASS HANDLE MUST BE RAISED TO THE UP OR OPEN POSITION BEFORE INSTALLING OR REMOVING METER.
CAUTION: IN THE UP POSITION THE LINE AND LOAD SOCKET JAWS ARE BRIDGED AND THEREFORE THE LOAD SIDE OF THE METER IS ENERGIZED.
2. NEVER USE THE BYPASS AS A JUMPING DEVICE IN LIEU OF A METER. NEVER INSTALL OR REMOVE THE METER WITHOUT DISCONNECTING THE LOAD.
3. THE CLEAR PLASTIC SHIELD IS TO GUIDE THE METER BLADES SAFELY INTO THE JAWS OF THE ENCLOSURE AND MUST NEVER BE REMOVED.
4. NO ENTRY IS TO BE MADE THROUGH THE TOP OF THIS ENCLOSURE.
5. CAUTION MUST BE OBSERVED TO MAKE SURE THAT THE LOAD CONNECTORS CANNOT ROTATE AND ACCIDENTLY CONTACT THE NEUTRAL STUD.
6. SEE SIM-ESIG SECTION 4 FOR OVERHEAD SERVICE INSTALLATION INSTRUCTIONS.
7. THE USE OF THIS ENCLOSURE IS EXPRESSLY PROHIBITED FOR ANY APPLICATION WHERE THE CONNECTED LOAD IS LESS THAN 200 AMPS, OR THE DEMAND LOAD IS GREATER THAN 320 AMPS. FURTHER, DO NOT USE ON ANY COMMERCIAL SERVICE THAT MAY HAVE FUTURE NEED TO INCREASE LOAD OR CHANGE TO THREE PHASE.
8. WHENEVER THIS ENCLOSURE IS USED THE SERVICE PLANNER MUST ARRANGE TO HAVE A 320 AMP S BASE METER INSTALLED IN IT.
9. THE USE OF THIS HEAVY DUTY ENCLOSURE ON AN OVERHEAD SERVICE WILL BE BY SPECIAL PERMISSION OF THE DECO SERVICE PLANNER.
10. IN THIS OVERHEAD APPLICATION, THE SERVICE RISER WILL ENTER THROUGH A FACTORY ELL OR CONDUIT BEND INTO THE LEFT OR RIGHT SIDE AS SHOWN. IF THERE IS AN UNAVOIDABLE SPACE PROBLEM, A 90° CONDUIT FITTING MAY BE USED.

DTE ELECTRIC COMPANY ASSUMES NO RESPONSIBILITY FOR INJURY OR DAMAGE ARISING FROM THE USE OF THIS SPECIFICATION DIAGRAM.

1Ø, CL320, 3W, 120/240V, METER ENCLOSURE

ANY BOND BETWEEN THE METER ENCLOSURE AND JOINT USERS THAT INTERFERES WITH REMOVING THE COVER ON THE METER BOX IS A VIOLATION OF NEC 250.94(A)(3). THE JOINT USER WHO CREATED THE VIOLATION MUST CORRECT THE SITUATION.

OPTIONAL KIT; TANG WITH 10-32 TAPPED HOLE FOR WATER HEATER LUG, USE #8 AWG WITH 10-32 X 3/8" SCREW WASHER & LOCK WASHER FOR BOTH PHASES. FURNISHED AND AND INSTALLED BY CONTRACTOR

OPTIONAL KIT; TANG WITH 10-32 TAPPED HOLE FOR WATER HEATER LUG, USE #8 AWG WITH 10-32 X 3/8" SCREW WASHER & LOCK WASHER FOR NEUTRAL FURNISHED AND INSTALLED BY CONTRACTOR.

UNDERGROUND APPLICATION

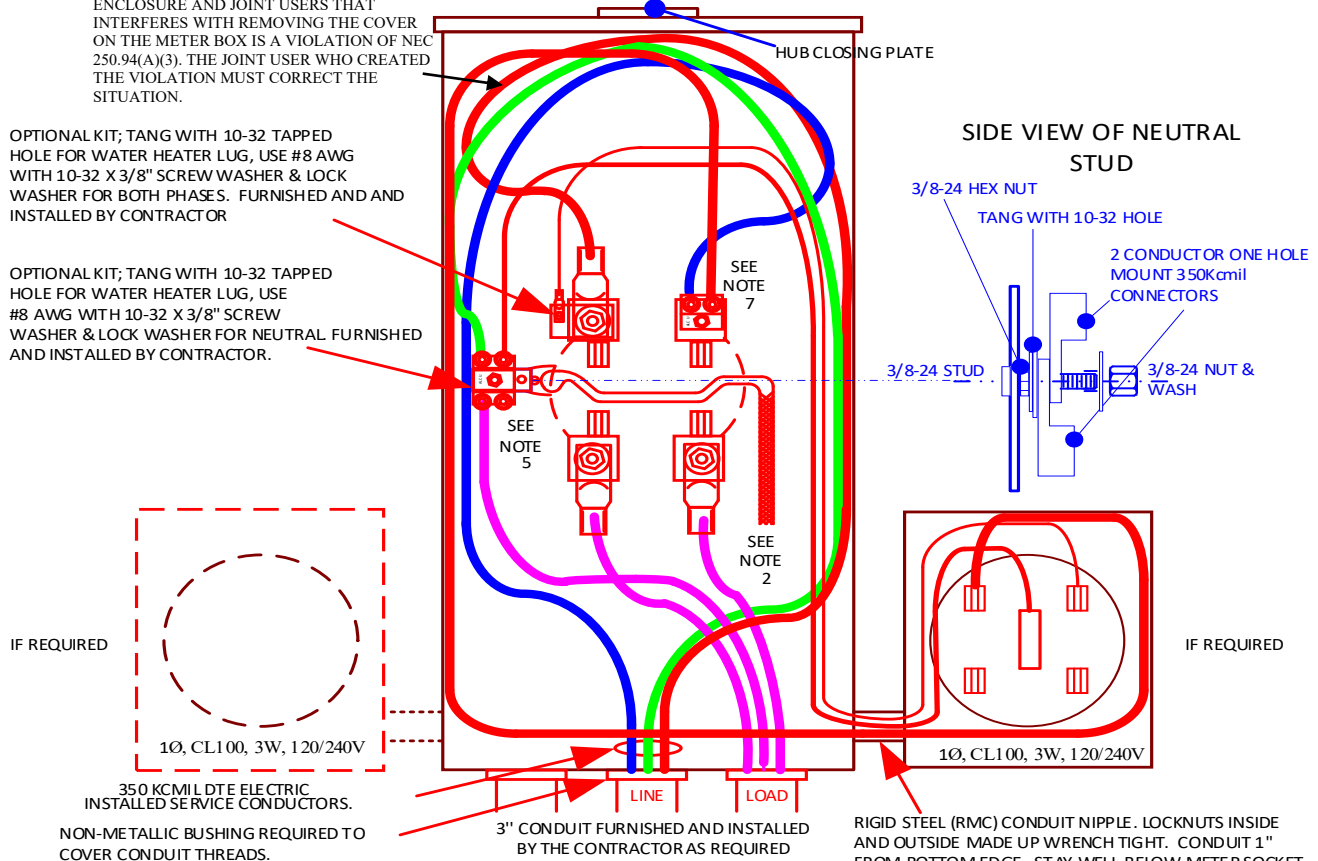

NOTES:

- ENTRY FOR UNDERGROUND SERVICE MUST BE KEPT BELOW METER SOCKET ON BOTTOM.
- THE BYPASS HANDLE MUST BE RAISED TO THE UP OR OPEN POSITION BEFORE INSTALLING OR REMOVING THE METER.
CAUTION: LINE AND LOAD SOCKET JAWS ARE BRIDGED WITH HANDLE UP. IN THIS POSITION THE LOAD SIDE OF THE METER IS ENERGIZED.
- NEVER USE THE BYPASS AS A JUMPING DEVICE IN LIEU OF A METER. NEVER INSTALL OR REMOVE THE METER WITHOUT DISCONNECTING ALL OF THE CUSTOMER'S LOAD.
- THE CLEAR PLASTIC SHIELD MUST EXTEND DOWN TO THE METER SOCKET BASE AND MUST NEVER BE REMOVED.
- CAUTION MUST BE OBSERVED TO MAKE SURE THAT THE LOAD CONNECTORS CANNOT ROTATE AND ACCIDENTALLY CONTACT THE NEUTRAL STUD. SEE TANG CONVERSION DETAIL FOR INSTALLING LINE AND LOAD CONNECTORS AND OPTIONAL TANG.
- SEE SIM-ESIG SECTION 3 FOR UNDERGROUND SERVICE INSTALLATION DETAILS.
- OPTIONAL LINE & LOAD LUGS FURNISHED AND INSTALLED BY THE CONTRACTOR. LUGS UL LISTED AS SUITABLE FOR MULTIPLE CONDUCTORS MUST BE USED. USE TWO DOUBLE CONNECTION LUGS BACK TO BACK FOR FOUR #6 TO 350Kcmil & NEUTRALS ALONG WITH THE OPTIONAL TANG CONVERSION KIT. THE TANG HAS A TAPPED 10-32 HOLE. USE FOR #8 OR #10 AWG CONDUCTORS. SEE 2023 NEC 230.31 SIZE AND AMPACITY, (B) MINIMUM SIZE. USE 10-32 X 3/8" SCREW, WASHER AND LOCK WASHER. NO MORE THAN TWO CONNECTIONS CAN BE MADE ON THE LOAD SIDE. ADDITIONAL CONNECTIONS SHALL BE MADE IN A SEPARATE JUNCTION BOX.
- THE USE OF THIS ENCLOSURE IS EXPRESSLY PROHIBITED FOR ANY APPLICATION WHERE THE CONNECTED LOAD IS LESS THAN 200 AMPS. OR THE DEMAND LOAD IS GREATER THAN 320 AMPS. DO NOT USE ON COMMERCIAL SERVICE THAT MAY HAVE FUTURE NEED TO INCREASE LOAD OR CHANGE TO THREE PHASE.
- THE DTE ELECTRIC PLANNER MUST ARRANGE TO HAVE A CLASS 320 METER INSTALLED IN THIS ENCLOSURE.

THE DTE ELECTRIC COMPANY ASSUMES NO RESPONSIBILITY FOR INJURY OR DAMAGE ARISING FROM THE USE OF THIS SPECIFICATION DIAGRAM.

1Ø, CL320, 3W, 120/240V METER ENCLOSURE OVERHEAD APPLICATION

ANY BOND BETWEEN THE METER ENCLOSURE AND JOINT USERS THAT INTERFERES WITH REMOVING THE COVER ON THE METER BOX IS A VIOLATION OF NEC 250.94 (A)(3). THE JOINT USER WHO CREATED THE VIOLATION MUST CORRECT THE SITUATION.

MAXIMUM SIZE CONDUIT 3" USE
HUB ON TOP ENTRY

OPTIONAL KIT; TANG WITH 10-32 TAPPED HOLE FOR WATER HEATER LUG, USE #8 AWG WITH 10-32 X 3/8" SCREW WASHER & LOCK WASHER FOR BOTH PHASES. FURNISHED AND INSTALLED BY CONTRACTOR

OPTIONAL KIT; TANG WITH 10-32 TAPPED HOLE FOR WATER HEATER LUG, USE #8 AWG WITH 10-32 X 3/8" SCREW WASHER & LOCK WASHER FOR NEUTRAL FURNISHED AND INSTALLED BY CONTRACTOR.

SIDE VIEW OF NEUTRAL STUD

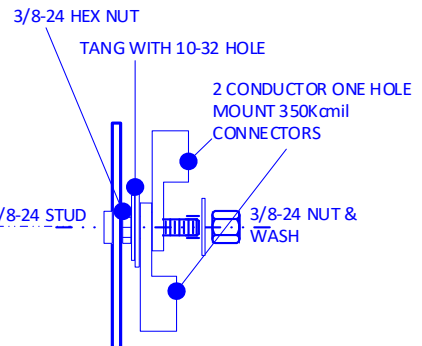

IF REQUIRED

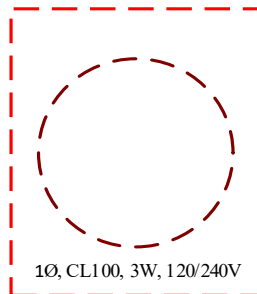

1Ø, CL100, 3W, 120/240V

SEE NOTE 5

SEE NOTE 4

SEE NOTE 1

IF REQUIRED

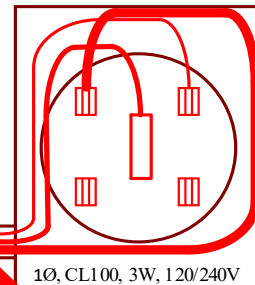

1Ø, CL100, 3W, 120/240V

NON-METALLIC BUSHING REQUIRED TO COVER CONDUIT THREADS.

3" CONDUIT FURNISHED AND INSTALLED BY THE CONTRACTOR AS REQUIRED

RIGID STEEL (RMC) CONDUIT NIPPLE. LOCKNUTS INSIDE AND OUTSIDE MADE UP WRENCH TIGHT. CONDUIT 1" FROM BOTTOM EDGE. STAY WELL BELOW METER SOCKET. SEAL BOX OPENINGS.

NOTES:

- THE BYPASS HANDLE MUST BE RAISED TO THE UP OR OPEN POSITION BEFORE INSTALLING OR REMOVING THE METER.
CAUTION: LINE AND LOAD SOCKET JAWS ARE BRIDGED WITH HANDLE UP. IN THIS POSITION THE LOAD SIDE OF THE METER IS ENERGIZED.
- NEVER USE THE BYPASS AS A JUMPING DEVICE IN LIEU OF A METER. NEVER INSTALL OR REMOVE THE METER WITHOUT DISCONNECTING ALL OF THE CUSTOMER'S LOAD.
- THE CLEAR PLASTIC SHIELD MUST EXTEND DOWN TO THE METER SOCKET BASE AND MUST NEVER BE REMOVED.
- CAUTION MUST BE OBSERVED TO MAKE SURE THAT THE LOAD CONNECTORS CANNOT ROTATE AND ACCIDENTALLY CONTACT THE NEUTRAL STUD. SEE TANG CONVERSION DETAIL FOR INSTALLING LINE AND LOAD CONNECTORS AND OPTIONAL TANG.
- OPTIONAL LINE & LOAD LUGS FURNISHED AND INSTALLED BY THE CONTRACTOR. LUGS UL LISTED AS SUITABLE FOR MULTIPLE CONDUCTORS MUST BE USED. USE TWO DOUBLE CONNECTION LUGS BACK TO BACK FOR FOUR #6 TO 350Kcmil & NEUTRALS ALONG WITH THE OPTIONAL TANG CONVERSION KIT. THE TANG HAS A TAPPED 10-32 HOLE. USE FOR #8 OR #10 AWG CONDUCTORS. SEE 2023 NEC 230.31 SIZE AND AMPACITY, (B) MINIMUM SIZE. USE 10-32 X 3/8" SCREW, WASHER AND LOCK WASHER. NO MORE THAN TWO CONNECTIONS CAN BE MADE ON THE LOAD SIDE. ADDITIONAL CONNECTIONS SHALL BE MADE IN A SEPARATE JUNCTION BOX.
- THE USE OF THIS ENCLOSURE IS EXPRESSLY PROHIBITED FOR ANY APPLICATION WHERE THE CONNECTED LOAD IS LESS THAN 200 AMPS. OR THE DEMAND LOAD IS GREATER THAN 320 AMPS. DO NOT USE ON COMMERCIAL SERVICE THAT MAY HAVE FUTURE NEED TO INCREASE LOAD OR CHANGE TO THREE PHASE.
- THE DTE ELECTRIC PLANNER MUST ARRANGE TO HAVE A CLASS 320 METER INSTALLED IN THIS ENCLOSURE.

THE DTE ELECTRIC COMPANY ASSUMES NO RESPONSIBILITY FOR INJURY OR DAMAGE ARISING FROM THE USE OF THIS SPECIFICATION DIAGRAM.

MULTIPLE METER INSTALLATION
 SINGLE PHASE, 3W, 120/240V, 2 POSITIONS, HORIZONTAL
 UNDERGROUND

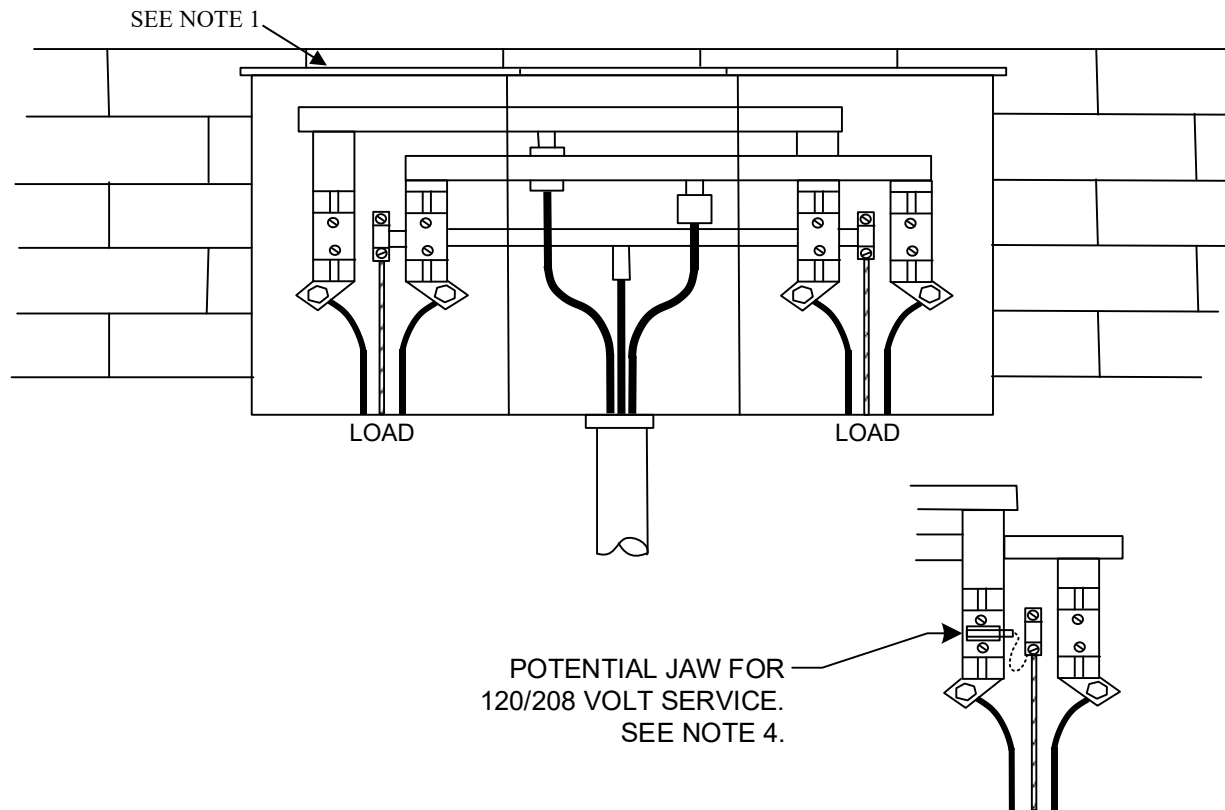
**NOTES:**

1. ANY BOND BETWEEN THE METER ENCLOSURE AND JOINT USERS THAT INTERFERES WITH REMOVING THE COVER ON THE METER BOX IS A VIOLATION OF NEC 250.94 (A)(3). THE JOINT USER WHO CREATED THE VIOLATION MUST CORRECT THE SITUATION.
2. THE ENCLOSURE HAS LINE SIDE TAP CONNECTIONS FOR ADDING AN ENCLOSURE FOR A WATER HEATER ACCOUNT OR FOR ISC FOR EITHER OR BOTH CUSTOMERS.
3. USE 3" CONDUIT FOR 350 KCMIL ON LINE SIDE AND MAXIMUM 250 KCMIL ON LOAD SIDE. PLANNER - CONSULT DESIGN PRACTICES FOR INSTALLATION CAPABILITY.
4. VOLTAGE 120/240, BUT MAY BE CONVERTED TO 120/208 BY THE ADDITION OF A NEUTRAL POTENTIAL FIFTH JAW. CUSTOMER WILL PROVIDE FIFTH JAW.
5. THERE ARE FIVE CONCENTRIC KNOCKOUTS: BOTTOM CENTER, EACH SIDE BELOW EACH METER POSITION AND ONE ON EACH SIDE PANEL. NO ENTRY IS TO BE MADE THROUGH THE TOP.
6. SEE SECTION 3 FOR INSTALLATION DIAGRAM AND OTHER PAGES IN THIS SECTION FOR INSTALLATION INSTRUCTIONS.
7. ALL WIRING SHOULD BE INSTALLED BY AN ELECTRICAL CONTRACTOR.

DTE ELECTRIC ASSUMES NO RESPONSIBILITY FOR INJURY OR DAMAGE
 ARISING FROM THE USE OF THIS SPECIFICATION DIAGRAM

MULTIPLE METER INSTALLATION

SINGLE PHASE, 3W, 120/240V, 2 POSITIONS, HORIZONTAL
OVERHEAD

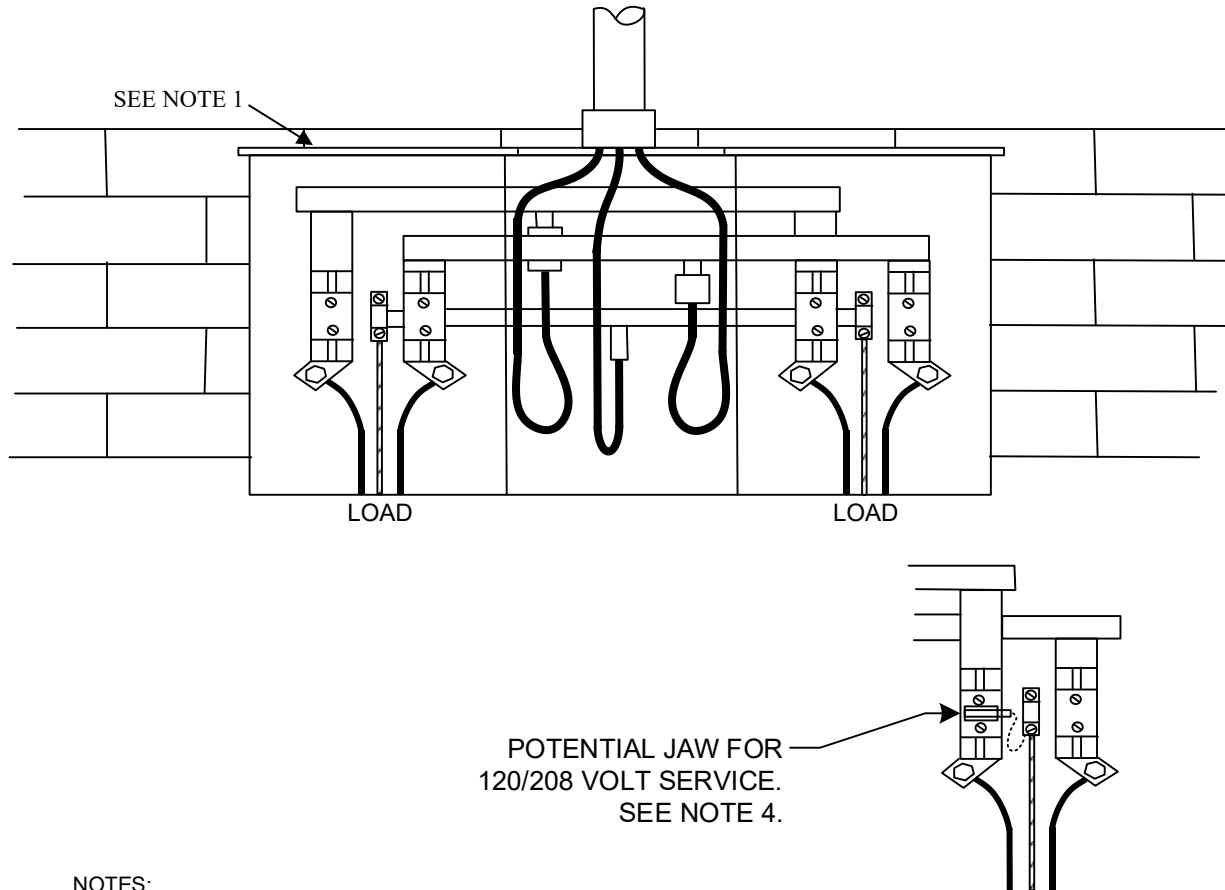

NOTES:

1. ANY BOND BETWEEN THE METER ENCLOSURE AND JOINT USERS THAT INTERFERES WITH REMOVING THE COVER ON THE METER BOX IS A VIOLATION OF NEC 250.94 (A)(3). THE JOINT USER WHO CREATED THE VIOLATION MUST CORRECT THE SITUATION.
2. THE ENCLOSURE HAS LINE SIDE TAP CONNECTIONS FOR ADDING AN ENCLOSURE FOR A WATER HEATER ACCOUNT OR FOR ISC FOR EITHER OR BOTH CUSTOMERS.
3. USE 3" CONDUIT FOR 350 KCMIL ON LINE SIDE AND MAXIMUM 250 KCMIL ON LOAD SIDE. PLANNER - CONSULT DESIGN PRACTICES FOR INSTALLATION CAPABILITY.
4. VOLTAGE 120/240, BUT MAY BE CONVERTED TO 120/208 BY THE ADDITION OF A NEUTRAL POTENTIAL FIFTH JAW. CUSTOMER WILL PROVIDE FIFTH JAW.
5. THERE ARE FIVE CONCENTRIC KNOCKOUTS: BOTTOM CENTER, EACH SIDE BELOW EACH METER POSITION AND ONE ON EACH SIDE PANEL.
6. SEE SECTION 3 FOR INSTALLATION DIAGRAM AND OTHER PAGES IN THIS SECTION FOR INSTALLATION INSTRUCTIONS.
7. ALL WIRING SHOULD BE INSTALLED BY AN ELECTRICAL CONTRACTOR.

DTE ELECTRIC ASSUMES NO RESPONSIBILITY FOR INJURY OR DAMAGE
ARISING FROM THE USE OF THIS SPECIFICATION DIAGRAM

MULTIPLE METER MAIN OR LOAD CENTER INSTALLATION

SINGLE PHASE, 3W, 120/240V, 2 POSITIONS, HORIZONTAL
UNDERGROUND

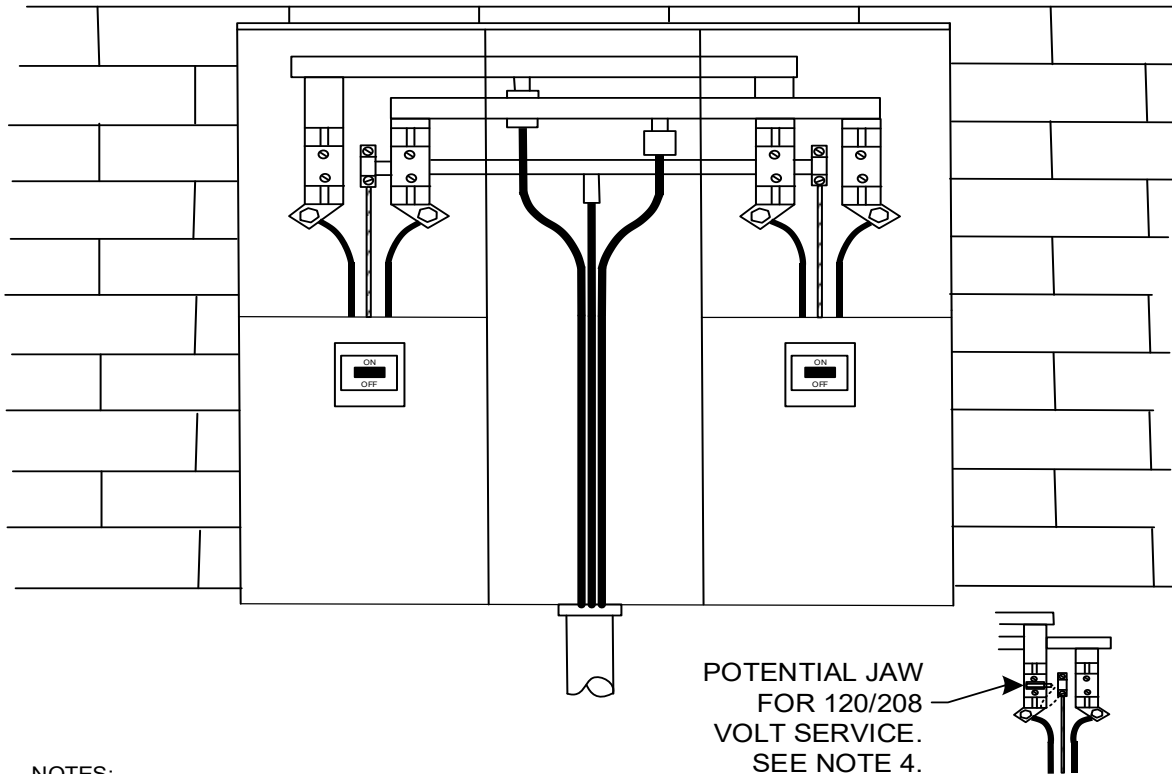

NOTES:

1. ANY BOND BETWEEN THE METER ENCLOSURE AND JOINT USERS THAT INTERFERES WITH REMOVING THE COVER ON THE METER BOX IS A VIOLATION OF NEC 250.94 (A)(3). THE JOINT USER WHO CREATED THE VIOLATION MUST CORRECT THE SITUATION.
2. THE ENCLOSURE HAS LINE SIDE TAP CONNECTIONS FOR ADDING AN ENCLOSURE FOR A WATER HEATER ACCOUNT OR FOR ISC FOR EITHER OR BOTH CUSTOMERS.
3. USE 3" CONDUIT FOR 350 KCMIL ON LINE SIDE AND MAXIMUM 250 KCMIL ON LOAD SIDE. PLANNER - CONSULT DESIGN PRACTICES FOR INSTALLATION CAPABILITY.
4. VOLTAGE 120/240, BUT MAY BE CONVERTED TO 120/208 BY THE ADDITION OF A NEUTRAL POTENTIAL FIFTH JAW. CUSTOMER WILL PROVIDE FIFTH JAW.
5. THERE ARE FIVE CONCENTRIC KNOCKOUTS: BOTTOM CENTER, EACH SIDE BELOW EACH METER POSITION AND ONE ON EACH SIDE PANEL. NO ENTRY IS TO BE MADE THROUGH THE TOP.
6. SEE SECTION 3 FOR INSTALLATION DIAGRAM AND OTHER PAGES IN THIS SECTION FOR INSTALLATION INSTRUCTIONS.
7. ALL WIRING SHOULD BE INSTALLED BY AN ELECTRICAL CONTRACTOR.
8. AN EXPANSION JOINT IS REQUIRED ON INCOMING SERVICE CONDUIT TO ACCOMMODATE THERMAL EXPANSION AND PREVENT DAMAGE TO SERVICE CONDUCTORS AND TERMINALS.

DTE ELECTRIC ASSUMES NO RESPONSIBILITY FOR INJURY OR DAMAGE
ARISING FROM THE USE OF THIS SPECIFICATION DIAGRAM

Single Phase
Meter Inspection and Installation Routine

Page 1 of 3

Inspection Date Wanted _____

Address _____ Bldg _____ Fl _____ Apt/Rm _____ City/Town _____

Remarks _____

Inspector _____ Date Inspected _____

Remarks _____

1. Address marked on stationary portion of meter enclosure Yes No
2. Safe and permanent access to metering equipment Yes No
3. **Working clearances** in front of meter enclosure:
min. 30" wide by 36" deep (min. 30" wide by 48" deep for 480 V) Yes No
4. Access clearances to meter enclosure:
min. 24" wide by 6' 6" high and clear of obstructions Yes No
5. Customer's service disconnect installed Yes No
6. Grounding electrode conductor installed and connected to
Grounding Electrode System (NEC) Yes No
Not to be routed through or terminated in meter enclosure
7. Check for correct voltages Not Energized Yes No

Single Phase
Meter Inspection and Installation Routine

Page 2 of 3

- 8. Approved DTE meter enclosure installed([see 5-8](#))..... Yes No
- 9. Line and load wires enter enclosure at approved locations Yes No
- 10. Any backfeed on line or load conductors Yes No
- 11. Any faults in line or load conductors Yes No
- 12. Was enclosure jumpered Yes No
- 13. Service entrance conduit type Metallic PVC (electrical)
- 14. Service conduit properly sized and supported([see 5-3-1](#))..... Yes No
- 15. Weatherhead or gooseneck min. 6" *above* attachment point N/A* Yes No
- 16. Service conductors extend min. 24" from weatherhead N/A* Yes No
- 17. Point of attachment to finished grade minimums met N/A* Yes No
Residential -- drip loop-10', driveway-12', street-18', hwy-22'
Commercial -- drip loop-12', bus-15', vehicular traffic-18', hwy-22'
- 18. Meter enclosure securely fastened with sides and face vertically plumb Yes No
- 19. Meter enclosure height max. 6' to top, min. 3' 6" to center of meter face Yes No

N/A* *Not Applicable*

Single Phase
Meter Inspection and Installation Routine

Page 3 of 3

- 20. Meter enclosure min. 1-foot horizontal clearance from inside corner..... Yes No
- 21. The edge of any metal or PVC terminal adapter, connector, or nipple entering meter box or tap box is covered with a nonmetallic bushing Yes No
- 22. Inspect meter enclosure for sealing hasp, openings sealed, block cond., etc. Yes No
- 23. Inspect and tighten all line, load, and neutral connections Yes No
- 24. Inspect for insulated neutral requirements ([See 5-1-3 #10 \(d\)](#))..... Yes No
- 25. Install meter and seal enclosure Yes No
- 26. 480 V label on inside meter enclosure and cover (DTE EFO) N/A* Yes No
- 27. Outdoor disconnect installed in compliance with 2023 NEC230.85. (Disconnects must be grouped and installed on the load side of the utility meter(s). Applies to one- and two-family dwellings)..... N/A* Yes No

N/A* *Not Applicable*

**SERVICE ENTRANCE AND METERING EQUIPMENT
FOR MULTIPLE OCCUPANCY BUILDINGS****I. SINGLE-PHASE SERVICE TO TENANTS**

There are two methods of installing DTE Electric metering equipment in multiple occupancy buildings for single-phase service to tenants:

Method One: Electrical contractor will furnish DTE approved standard single meter enclosures, which the electrical contractor will install using trough, conduit or other suitable means. They may also be mounted on panels along with the over-current devices. Sealing arrangements and separation of metered and unmetered conductors must be approved by DTE Electric.

NOTE: Service into the bottom of the meter enclosure from the trough and load out the top of the meter enclosure is NOT ALLOWED.

Method Two: DTE Electric will list the manufacturer and catalog numbers of multiple meter equipment, which has been accepted for metering tenant accounts in multiple occupancy buildings. This equipment will be purchased, installed, owned, and maintained by the building owner. Purchase will be from independent distributors of the approved equipment on the list. Consult manufacturers for the names of distributors in this area.

Meter equipment manufacturers and catalog numbers are listed in section 5-8. These are the only units of such equipment that are acceptable for the use of metering new DTE Electric tenant accounts in multiple occupancy buildings.

II. THREE PHASE SERVICE TO TENANTS

For services not exceeding 240V see the two methods above for installing DTE Electric metering equipment in multiple occupancy buildings for three-phase service to tenants.

For three-phase 277/480V, 200A, commercial multi-metering applications use: Method One above or a Commercial metering switchboard manufactured by a company listed on page 5-6-12 and using meter sockets preapproved by DTE Electric for single position 480V meter enclosures as listed in section 5-8 "Three Phase, Ringless, Self Contained, 7 Terminals, 480V, With Lever Bypass And Jaw Release". Indoor installations require a Main Switch or Circuit Breaker. No unused metering positions are allowed. See 5-3-12 for reference. See 5-3-26 and 5-3-27 for inspection routine.

NOTE: The standard metering for new DTE Electric three-phase accounts is the S-base (socket) polyphase solid-state meter. These include a lever bypass and jaw release for 277/480V self-contained meter sockets.

III. RESIDENTIAL HIGH-RISE AND APARTMENT BUILDINGS

DTE Electric shall be consulted for requirements for high-rise buildings having three or more floors. This consultation is to include but is not limited to, the number of metering rooms, the location of the metering room(s), and accessibility. The customer shall furnish modular grouped meter installations with individual breakers for residential high-rise and apartment buildings. DTE Electric will list the manufacturer and catalog numbers of multiple meter equipment, which has been accepted by DTE Electric for metering tenant accounts in multiple occupancy buildings. This equipment will be purchased, installed, owned, and maintained by the building owner. Purchase will be from independent distributors of the approved equipment on the list. Consult manufactures for the names of distributors in this area. Multiple meter equipment manufacturers and catalog numbers are listed in section 5-8. This is the only equipment that will be acceptable to meter new DTE Electric tenant accounts in multiple occupancy buildings. Sealing arrangements and separation of metered and unmetered conductors must be approved by DTE Electric Meter Engineering. If primary fed, residential metering that requires “dry-type” transformers to be installed on the line side of the metering equipment shall be provided and owned by DTE Electric. Specifications for the installation of these transformers will be provided by DTE Electric. The DTE Electric owned transformers will reside in the same meter room as the metering equipment.

IV. COMBINATION COMMERCIAL (RETAIL) & RESIDENTIAL HIGH RISE SERVICES

DTE Electric shall be consulted for requirements for the design of combined electrical services requiring both commercial and residential metering equipment having three or more floors. For primary fed customers, residential metering that requires “dry-type” transformers to be installed on the line side of the metering equipment shall be provided and owned by DTE Electric. Specifications for the installation of these transformers will be provided by DTE Electric. The DTE Electric owned transformers will reside in the same meter room as the metering equipment. The customer shall consult with DTE Electric to determine the number of metering rooms required, the location of the metering room(s), sealing of all line conductors including transformer(s), and accessibility. Sealing arrangements and separation of metering and unmetered conductors must be approved by DTE Electric Meter Engineering.

The customer shall be responsible for consulting with DTE Electric for specific design criteria to address voltage drop standards.

DTE Electric will list the manufacturer and catalog numbers of multiple meter equipment, which has been accepted by DTE Electric for metering tenant accounts in multiple occupancy buildings. This equipment will be purchased, installed, owned, and maintained by the building owner. Purchase will be from independent distributors of the approved equipment on the list. Consult manufacturers for the names of distributors in this area. Multiple meter equipment manufactures and catalog numbers are listed in section 5-8. This is the only equipment that will be acceptable to meter new DTE Electric tenant accounts in multiple occupancy buildings.

NOTE: The standard metering for new DTE Electric, three-phase accounts is the S-Base (socket) polyphase solid state meter. These include a lever bypass and jaw release for all self contained meter sockets.

**VMS* MULTIPLE METER PANELS
SINGLE PHASE 120/240 OR 120/208 VOLT
THREE HIGH, FOUR HIGH, FIVE HIGH, OR SIX HIGH
SPECIFICATION NOTES**

1. Service Cables or main feeder cables must be connected into the VMS* Main Service Unit**. Vertical Stacks will be directly connected into the VMS Main Service Unit from one VMS to the adjoining VMS with the connection hardware furnished with the units.
2. Housing to housing screws must be firmly fastened to securely close the mating surfaces.
3. See the table on page 5-8-1 through 5-8-12 for catalog numbers.
4. Meter assembly panel and VMS Main Service Unit furnished and installed by contractor.
5. Refer to Section 7 for Water Heater installation diagrams.
6. Outdoor models are available, see table referred to in note 3 above.
7. Tenant main feeder must generally exit through the top or bottom of the VMS in which it terminates. VMS housings are never to be used as a raceway for conductors terminated in another VMS. (Exception: Water heater relay control circuit may pass from one VMS to the next).
8. DTE Electric approved 120/208-volt wye meters and metering equipment to be supplied by customer or contractor.
9. All multiple metering housing cover mounting screws must be furnished and installed by contractor, top, bottom and below each meter opening.
10. The DTE Electric assumes no responsibility for injury or damage arising from the use of these specifications.
11. Contractor must furnish VERTICAL METER STACKS and SCREW-TYPE sealing rings.
12. Mounting height must conform to Company requirements. (See page 5-3-11)
13. Service feeds to VMS units are required to be installed in conduit back to DTE Electric service equipment. Consult with DTE Electric Planner for exceptions.

* VMS – Vertical Meter Stack

** Main Service Unit – Main Circuit Breaker, Fusible Switch or Terminal Box

MULTIPLE METER PANELS

1Ø, 120/240V OR 120/208V
3 TO 6 HIGH

ALL METERS MUST FOLLOW NUMERICAL ADDRESS ORDER
FROM TOP TO BOTTOM AND LEFT TO RIGHT

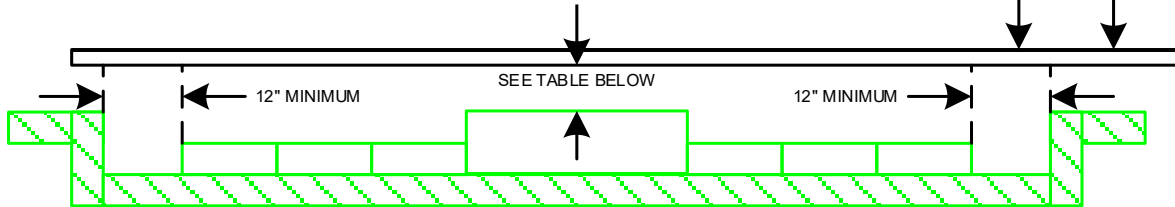
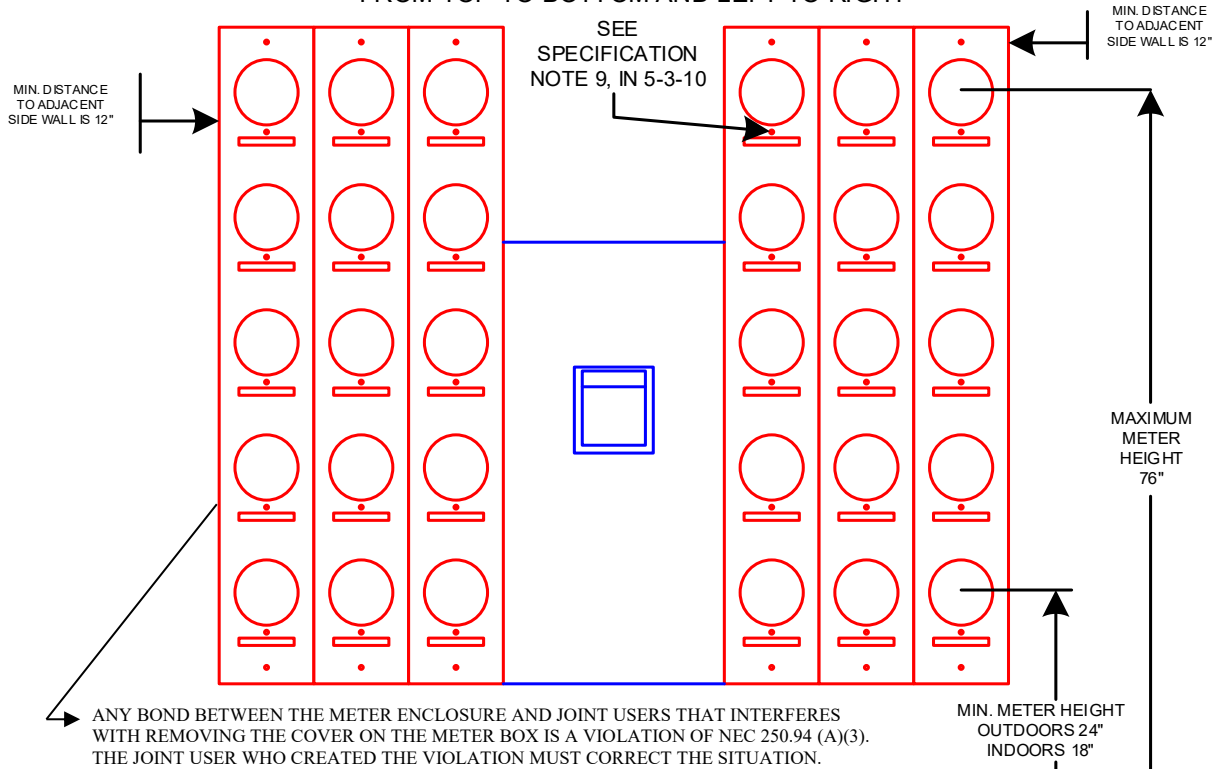

**MINIMUM WORKING SPACE
PER NFPA 70, NEC TABLE 110.26(A)(1)**

MAXIMUM CLEARANCES		
CONDITIONS	0-150V	151-600V
1 INSULATED WALL IN FRONT OF EQUIPMENT	3'	3'
2 WALL IN FRONT OF EQUIPMENT GROUNDED TO EARTH	3'	3 1/2'
3 EQUIPMENT ACROSS FROM EQUIPMENT WITH EXPOSED LIVE PARTS	3'	4'

THESE DIMENSION ARE FOR INSIDE OR OUTSIDE INSTALLATIONS
DTE ELECTRIC COMPANY ASSUMES NO RESPONSIBILITY FOR INJURY
OR DAMAGE ARISING FROM THE USE OF THIS SPECIFICATION DIAGRAM

COMMERCIAL METERING SWITCHBOARD
INSTALLATION 277/480V 3 PHASE

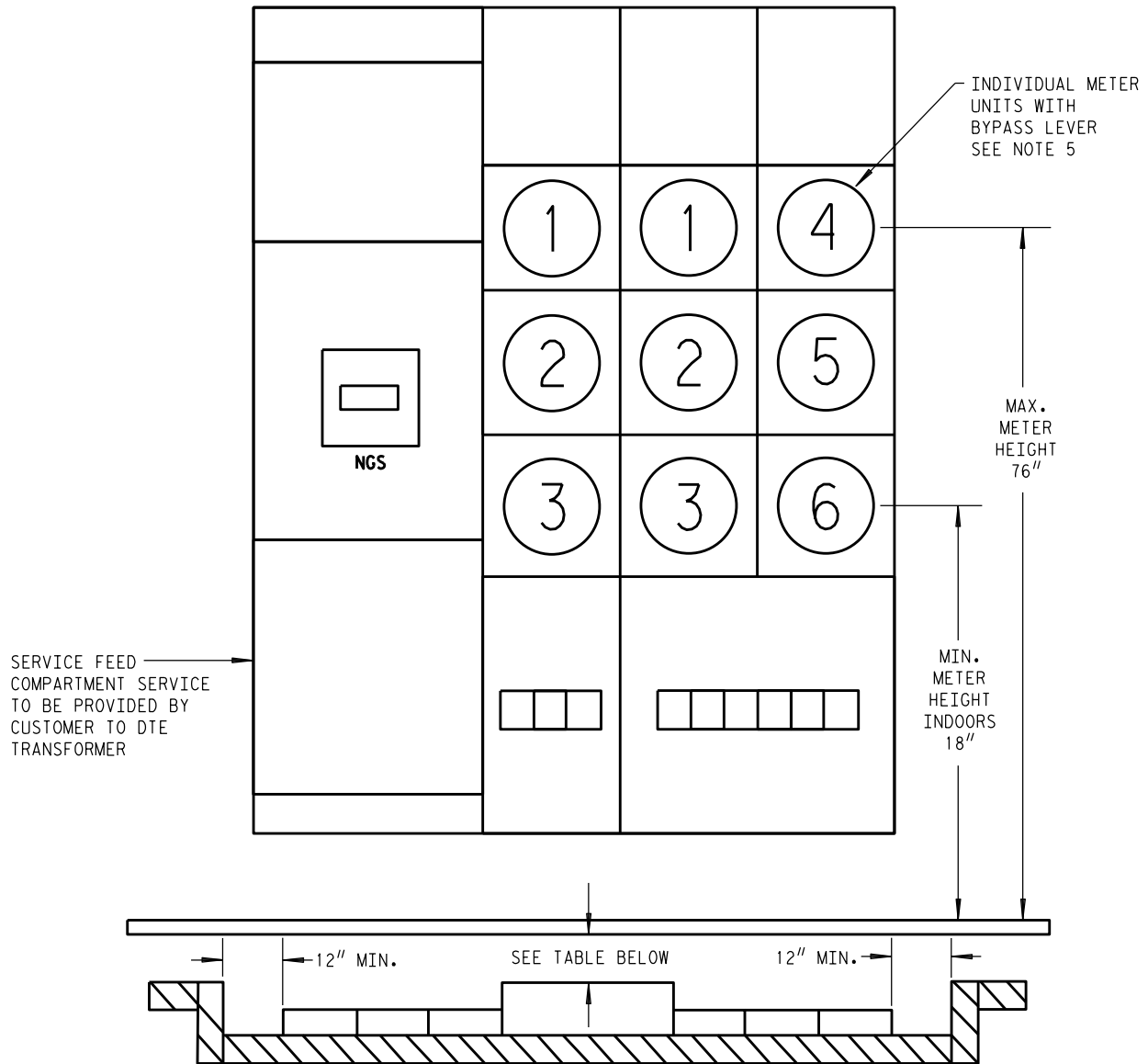

NOTES:

1. BARRIERS ARE REQUIRED TO SEPARATE THE METERING AREA FROM ANY OTHER AREAS IN THE SWITCHBOARD ASSEMBLY WHICH CONTAIN EQUIPMENT OR CONDUCTORS CARRYING METERED CURRENT.
2. ALL METERS MUST BE TAGGED WITH ADDRESS/UNIT LABELS AND SWITCHBOARD COMPONENT SHALL HAVE BUILDING NUMBER.
3. CUSTOMERS SHALL PROVIDE MANUFACTURER'S NAME, MODEL # AND DATA/CUT SHEET OF EQUIPMENT FOR DTE APPROVAL BEFORE PURCHASING EQUIPMENT. THE SWITCHGEAR AND SELF-CONTAINED METERS MUST BE DTE PRE-APPROVED.
4. ALL OUTDOOR EQUIPMENT WILL HAVE APPROPRIATE WEATHER TIGHT CONSTRUCTION AND APPROVED DTE DOOR SEAL HASPS. OUTDOOR EQUIPMENT ENCLOSURE DOORS WILL BE TAGGED TO IDENTIFY INTERNAL EQUIPMENT.
5. ANY BOND BETWEEN THE METER ENCLOSURE AND JOINT USERS THAT INTERFERES WITH REMOVING THE COVER ON THE METER BOX IS A VIOLATION OF NEC 250.94 (A)(3). THE JOINT USER WHO CREATED THE VIOLATION MUST CORRECT THE SITUATION.

MIN. WORKING CLEARANCES
NEC TABLE 110.26(A)(1)

CONDITION	0-150V	151-600V
1 INSULATED WALL IN FRONT OF EQUIPMENT	3'	3'
2 WALL IN FRONT OF EQUIPMENT GROUNDED TO EARTH	3'	3-1/2'
3 EQUIPMENT ACROSS FROM EQUIPMENT WITH EXPOSED LIVE PARTS	3'	4'

DIMENSIONS ARE FOR INSIDE OR OUTSIDE INSTALLATIONS

DTE ELECTRIC COMPANY ASSUMES NO RESPONSIBILITY FOR INJURY OR DAMAGE ARISING FROM THE USE OF THIS SPECIFICATION DIAGRAM.

MULTIPLE METER INSTALLATION

"S" TYPE METER ENCLOSURES INDOOR INSTALLATION NO PROVISIONS FOR FUTURE LOAD METERING EQUIPMENT

ANY BOND BETWEEN THE METER ENCLOSURE AND JOINT USERS THAT INTERFERES WITH REMOVING THE COVER ON THE METER BOX IS A VIOLATION OF NEC 250.94 (A)(3). THE JOINT USER WHO CREATED THE VIOLATION MUST CORRECT THE SITUATION.

LEGEND:

1. WIREWAY FURNISHED AND INSTALLED BY CONTRACTOR.
2. SWITCH OR CIRCUIT BREAKER FURNISHED & INSTALLED BY CONTRACTOR.
3. METER ENCLOSURE FURNISHED & INSTALLED BY CONTRACTOR.
4. APT. MAIN DISCONNECT FURNISHED & INSTALLED BY CONTRACTOR.

NOTES:

- A. THIS INSTALLATION WILL NOT ACCOMMODATE FUTURE ADDITIONS TO SERVICE EQUIPMENT AND SHOULD BE USED ONLY WHEN SPACE LIMITATIONS PROHIBIT A SINGLE ROW BANK.
- B. COVERS OF ALL ENCLOSURES CONTAINING CONDUCTORS CARRYING UNMETERED CURRENT SHALL BE EQUIPMENT WITH APPROVED SEALING DEVICES.
- C. METER ENCLOSURES, DISCONNECTING AND OVERCURRENT PROTECTIVE DEVICES LOCATED OUTSIDE THE AREA WHERE THE SERVICE ENTERS THE BUILDING SHALL HAVE AN INSULATED NEUTRAL AS WELL AS NEUTRAL CONNECTIONS IN ACCORDANCE WITH CODE REQUIREMENTS.
- D. METER ENCLOSURES MUST BE MOUNTED WITH SIDE AND FRONT FACES VERTICALLY PLUMB.

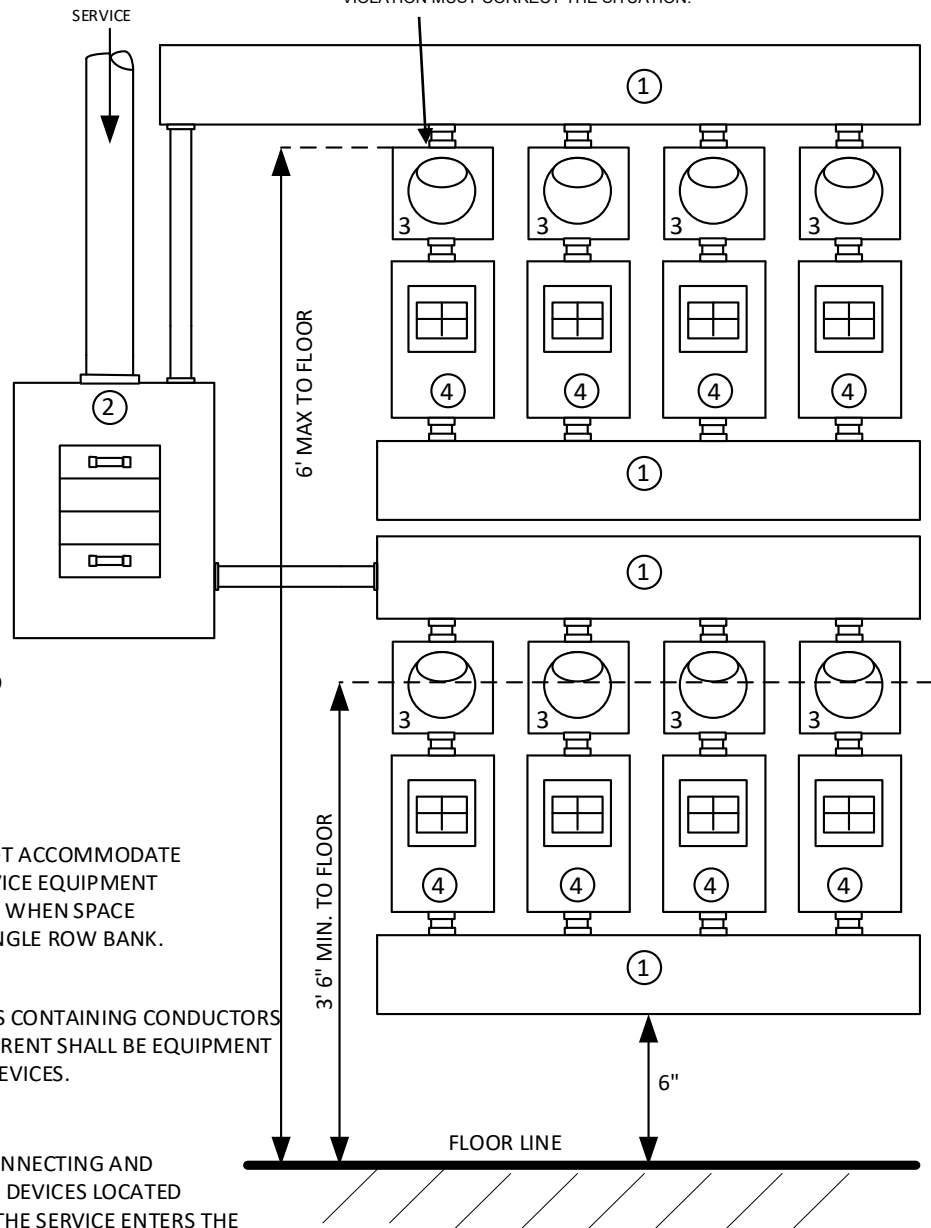

DTE ELECTRIC ASSUMES NO RESPONSIBILITY FOR INJURY OR DAMAGE ARISING OUT OF THE USE OF THIS SPECIFICATION DIAGRAM.

MULTIPLE METER INSTALLATION

"S" TYPE METER ENCLOSURES

INDOOR INSTALLATION

PROVISIONS FOR FUTURE LOAD METERING EQUIPMENT

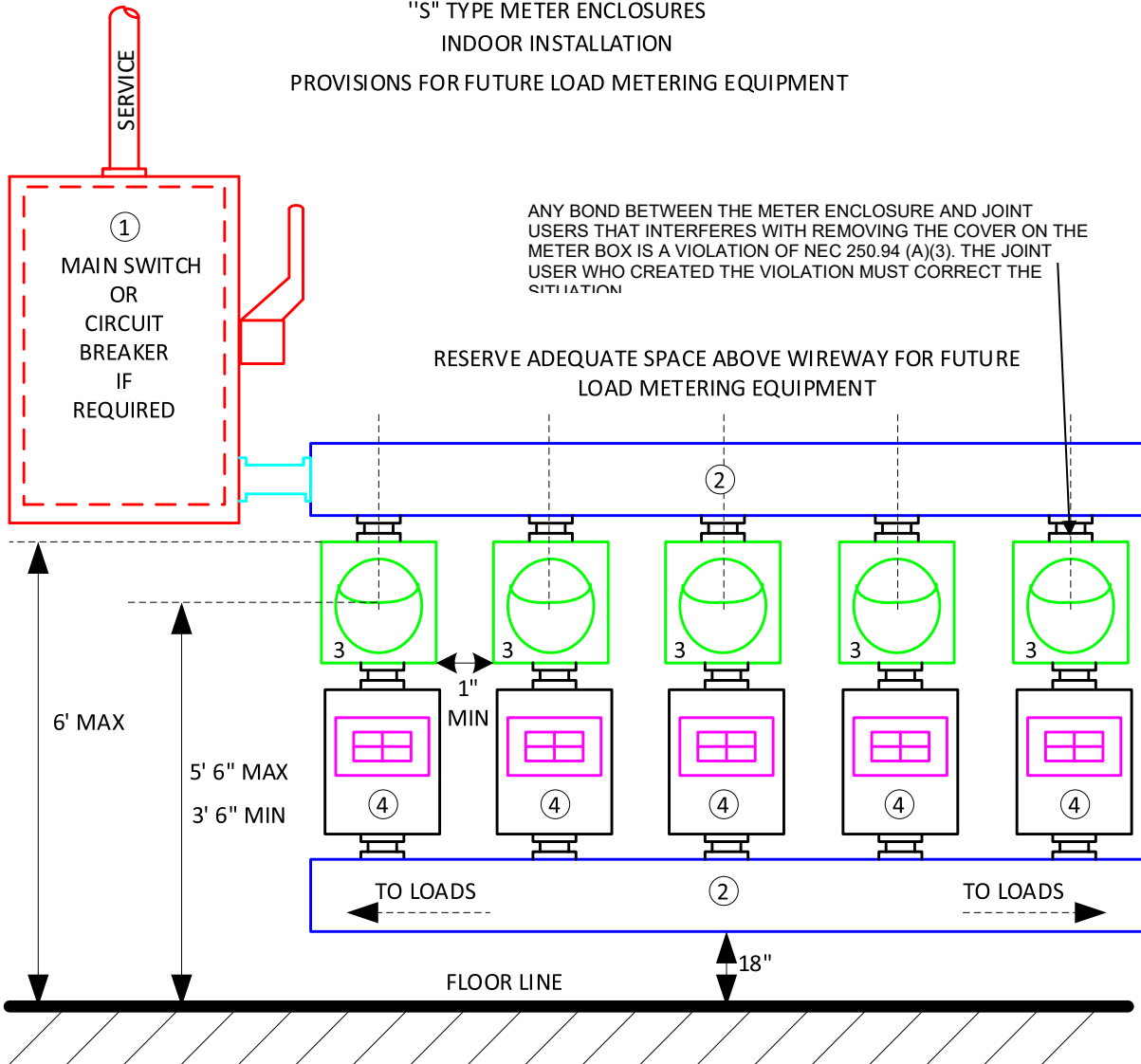

ANY BOND BETWEEN THE METER ENCLOSURE AND JOINT USERS THAT INTERFERES WITH REMOVING THE COVER ON THE METER BOX IS A VIOLATION OF NEC 250.94 (A)(3). THE JOINT USER WHO CREATED THE VIOLATION MUST CORRECT THE SITUATION

RESERVE ADEQUATE SPACE ABOVE WIREWAY FOR FUTURE LOAD METERING EQUIPMENT

LEGEND:

- 1. SWITCH OR CIRCUIT BREAKER FURNISHED AND INSTALLED BY CONTRACTOR.
- 2. WIREWAY FURNISHED AND INSTALLED BY CONTRACTOR.
- 3. APPROVED METER ENCLOSURE FURNISHED AND INSTALLED BY CONTRACTOR.
- 4. APT. MAIN DISCONNECT FURNISHED AND INSTALLED BY CONTRACTOR.

NOTES:

- A. THIS INSTALLATION WILL ACCOMMODATE FUTURE ADDITIONS TO SERVICE EQUIPMENT.
- B. COVERS OF ALL ENCLOSURES CONTAINING CONDUCTORS CARRYING UNMETERED CURRENT SHALL BE EQUIPPED WITH APPROVED SEALING DEVICES.
- C. METER ENCLOSURES, DISCONNECTING AND OVERCURRENT PROTECTION DEVICES LOCATED OUTSIDE THE AREA WHERE THE SERVICE ENTERS THE BUILDING SHALL HAVE INSULATED NEUTRALS AND NEUTRAL CONNECTIONS IN ACCORDANCE WITH CODE REQUIREMENTS.
- D. METER ENCLOSURES MUST BE MOUNTED WITH THE SIDE AND FRONT FACE VERTICALLY PLUMB.

THE DTE ELECTRIC COMPANY ASSUMES NO RESPONSIBILITY FOR INJURY OR DAMAGE ARISING FROM THE USE OF THIS SPECIFICATION DIAGRAM.

MULTIPLE METER INSTALLATION

"S" TYPE, 1Ø, METER ENCLOSURES
OUTDOOR TERMINAL CABINET INSTALLATION

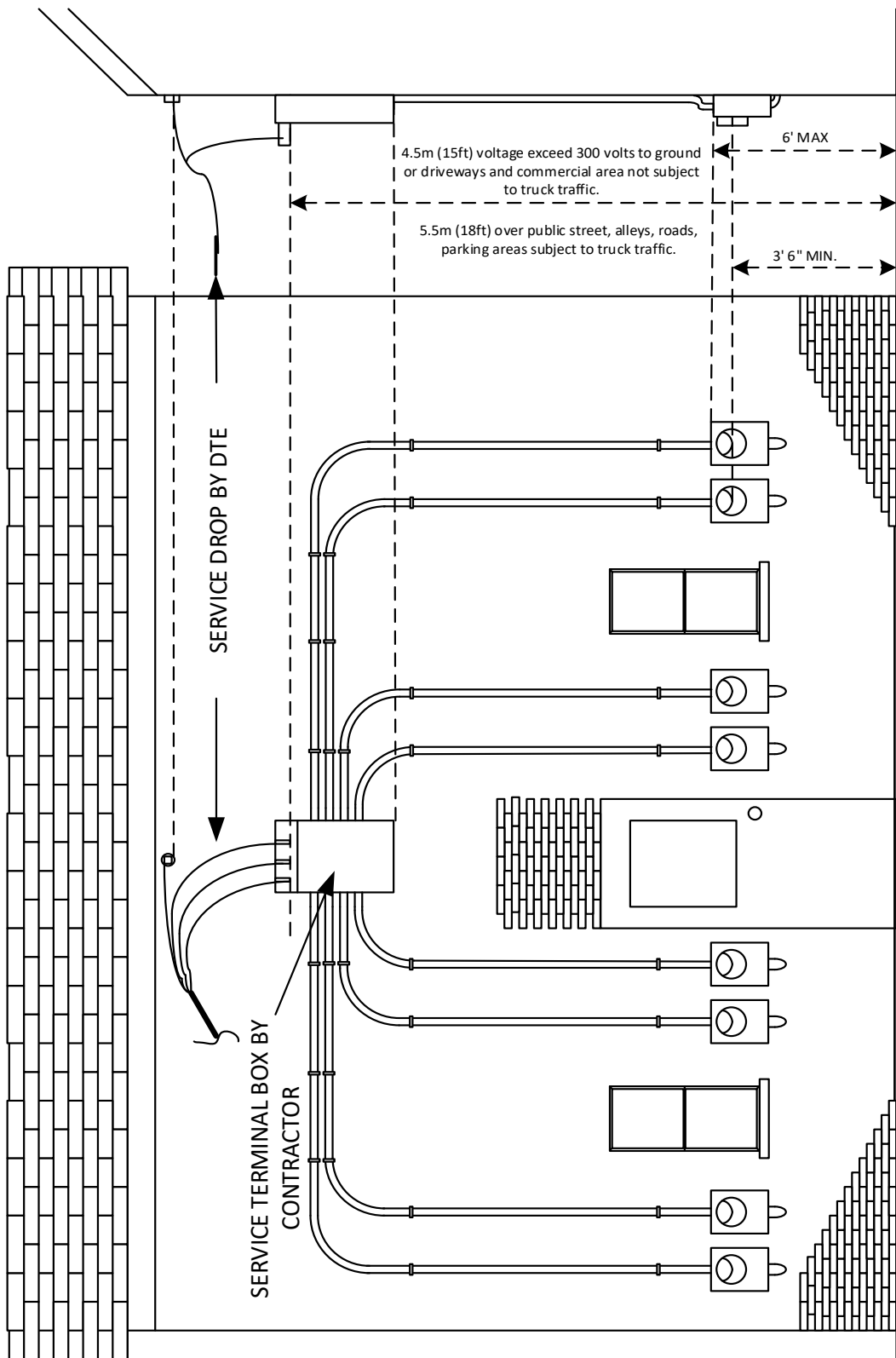

METER ENCLOSURES FURNISHED BY CONTRACTOR

DTE ELECTRIC ASSUMES NO RESPONSIBILITY FOR INJURY OR DAMAGE ARISING OUT OF THE USE OF THIS SPECIFICATION DIAGRAM.

MULTIPLE METER INSTALLATION

"S" TYPE SINGLE PHASE METER ENCLOSURES

OUTDOOR TROUGH INSTALLATION

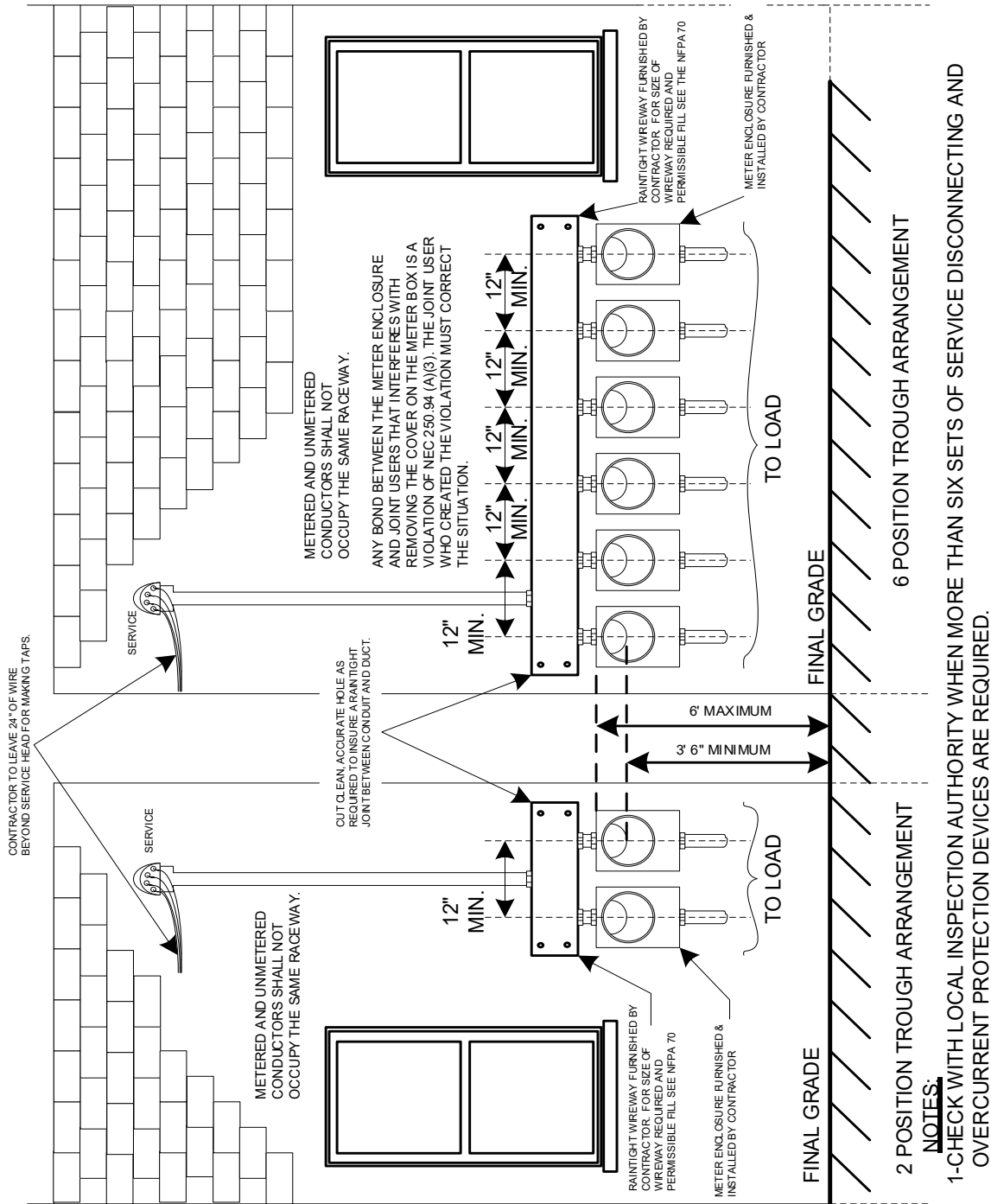

DTE ELECTRIC COMPANY ASSUMES NO RESPONSIBILITY FOR INJURY OR DAMAGE ARISING FROM THE USE OF THIS SPECIFICATION DIAGRAM.

SELF-CONTAINED METER ENCLOSURES

3Ø, CL200, 4W, WYE or DELTA (7 TERMINALS)

UNDERGROUND

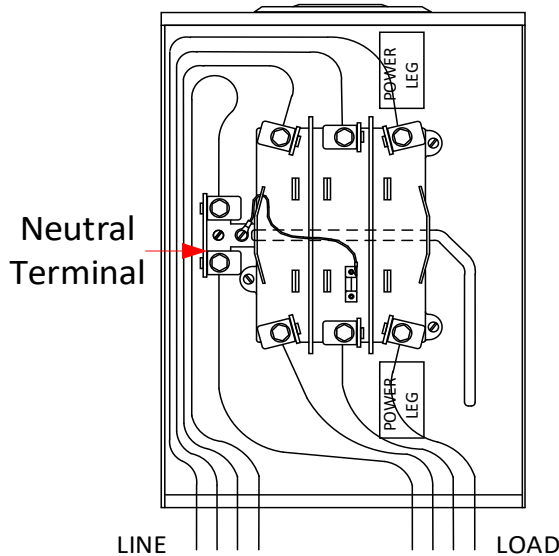

OVERHEAD

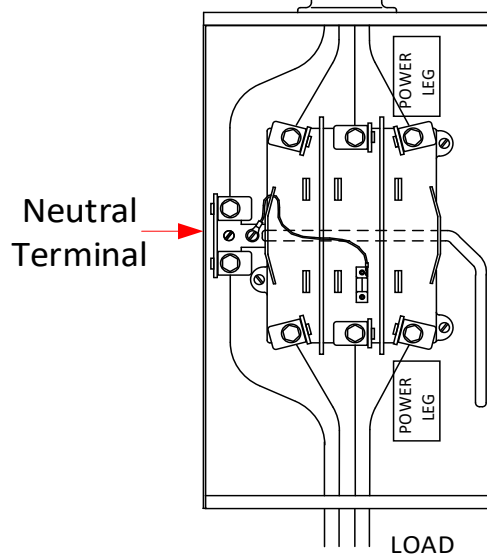

1. UG LINE CONDUCTORS MUST ENTER THE BOTTOM LEFT SIDE AND TRAIN UP THE LEFT SIDE ONLY.
2. 120/240V DELTA SERVICES WILL HAVE THE POWER LEG TERMINATED IN THE RIGHT SIDE METER BLOCK LUG (AS ILLUSTRATED).
3. ANY BOND BETWEEN THE METER ENCLOSURE AND JOINT USERS THAT INTERFERES WITH REMOVING THE COVER ON THE METER BOX IS A VIOLATION OF NEC 250.94 (A)(3). THE JOINT USER THAT CREATED THE VIOLATION MUST CORRECT THE SITUATION.

3Ø, CL200, 3W, DELTA (5 TERMINALS)

UNDERGROUND

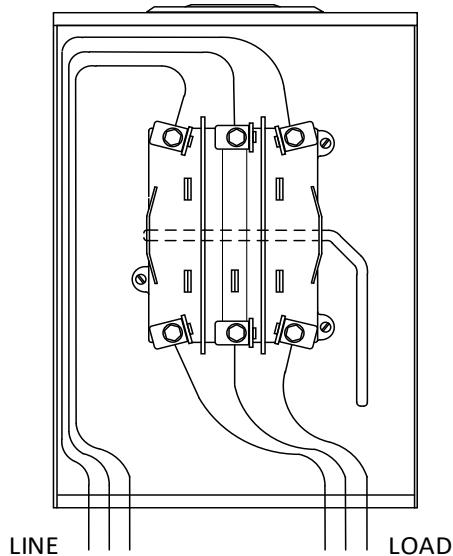

OVERHEAD

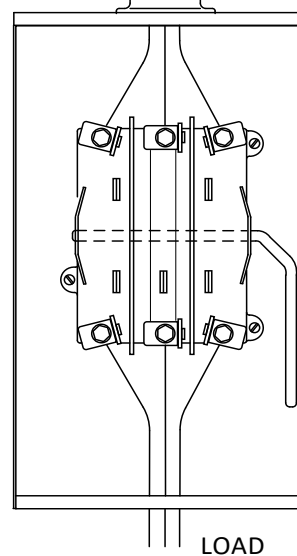

1. UG LINE CONDUCTORS MUST ENTER THE BOTTOM LEFT SIDE AND TRAIN UP THE LEFT SIDE ONLY.

3Ø, CL200, 4W, WYE or DELTA METER ENCLOSURES (7 TERMINALS)

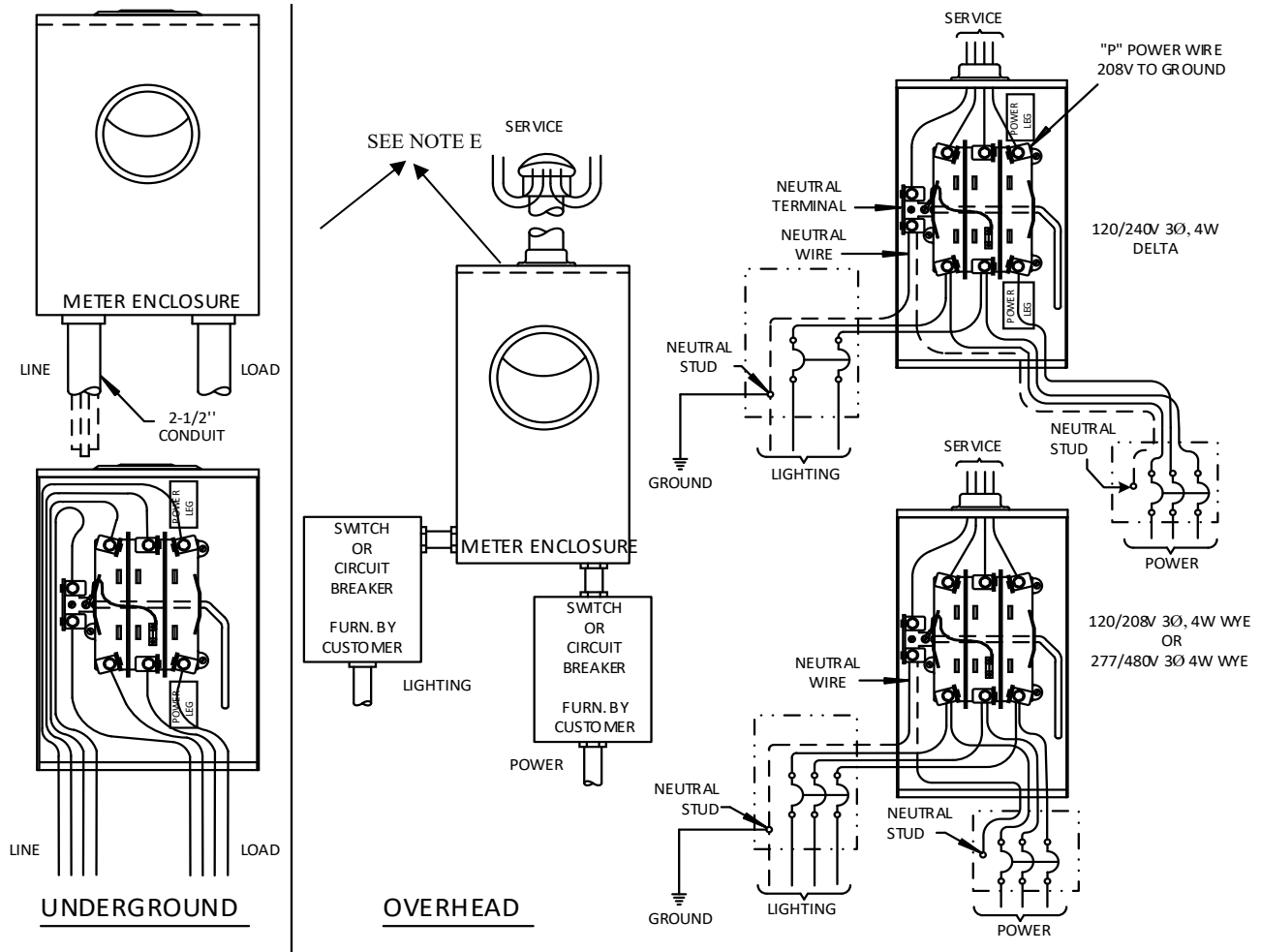

METER ENCLOSURE	WIRE SIZE	HUB SIZE	AMPERE	ISOLATED NEUTRAL
SELF CONTAINED 3 WIRE DELTA 4 WIRE DELTA 4 WIRE WYE	#6 THRU 350 KCMIL	OH - MIN 2 1/2" HUB UG - PLATE	200 MAXIMUM	CONTRACTOR SUPPLY

NOTES:

- A. LOAD WIRES MAY ENTER THE ENCLOSURE THROUGH THE SIDE, BACK, OR BOTTOM. HOWEVER, BACK ENTRY IS ALLOWED ONLY IF THE CENTER OF THE HOLE FOR THE CONDUIT IS LOCATED BETWEEN 2" AND 3" FROM THE BOTTOM AND CENTERED BETWEEN THE SIDES OF THE ENCLOSURE. CONDUCTOR TRAINING IN THE RIGHT SIDE OF THE ENCLOSURE IS PROHIBITED.
- B. THE POWER LEG OF A 120/240V 3Ø DELTA SERVICE MUST BE TERMINATED IN THE RIGHT SIDE METER LUG.
- C. UNDERGROUND SERVICE SHALL ENTER THE ENCLOSURE AT THE BOTTOM LEFT HAND SIDE ONLY.
- D. SEE INSTALLATION INSTRUCTIONS THIS SECTION.
- E. ANY BOND BETWEEN THE METER ENCLOSURE AND JOINT USERS THAT INTERFERES WITH THE COVER ON THE METER BOX IS A VIOLATION OF NEC 250.94 (A)(3). THE JOINT USER WHO CREATED THE VIOLATION MUST CORRECT THE SITUATION

DTE ELECTRIC COMPANY ASSUMES NO RESPONSIBILITY FOR INJURY OR DAMAGE ARISING FROM THE USE OF THIS SPECIFICATION DIAGRAM.

CL20, CT-Rated Meter Enclosure

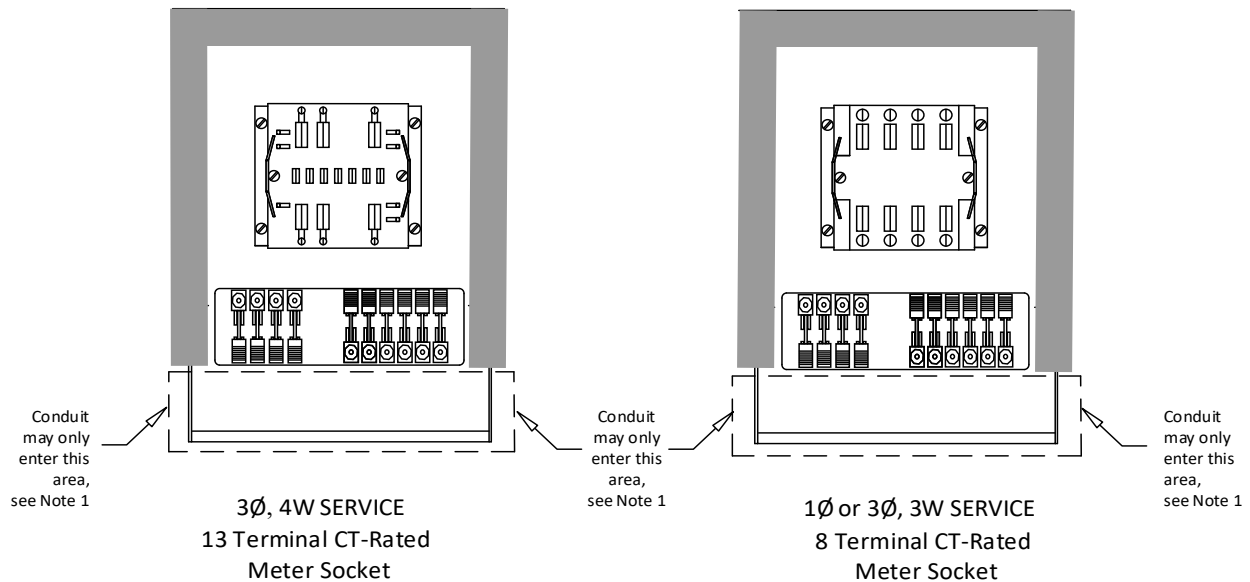

METER ENCLOSURE	WIRE SIZE	HUB SIZE	AMPERE	ISOLATED NEUTRAL
CT-Rated 3 Wire CT-Rated 4 Wire	CT's ONLY	SOLID TOP	20 MAXIMUM	ISOLATED ONLY

1. THE 1 1/4" METAL CONDUIT MAY ONLY ENTER THE METER SOCKET IN THE DESIGNATED AREA LOCATED JUST BELOW THE TEST SWITCH (THRU BOTTOM, BACK, OR SIDE).
2. IN SWITCHBOARDS, CURRENT TRANSFORMER CABINETS, AND CONNECTION CABINETS FOR 120/240V DELTA SERVICES THE POWER LEG SHALL BE TERMINATED IN THE CENTER POSITION.
3. METER SOCKETS MUST BE GROUPED WITH CT CABINETS.
4. ANY BOND BETWEEN THE METER ENCLOSURE AND JOINT USERS THAT INTERFERES WITH REMOVING THE COVER ON THE METER BOX IS A VIOLATION OF NEC 250.94 (3). THE JOINT USER WHO CREATED THE VIOLATION MUST CORRECT THE SITUATION.

20A CT-RATED METER SOCKET

(WITH LEVER BYPASS AND JAW RELEASE)

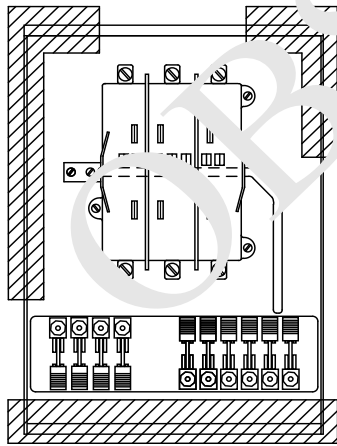
OBSOLETE

ZS3-20 FOR 4 WIRE SERVICE
13 TERMINAL CT METER SOCKET

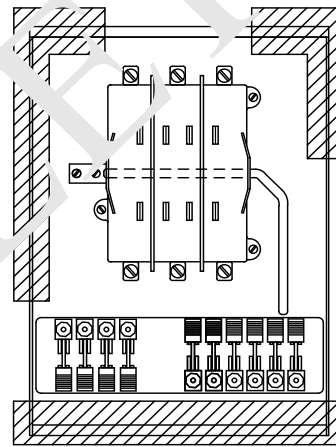

ZS3-20-5S FOR 3 WIRE SERVICE
8 TERMINAL CT METER SOCKET

MULTIPLE METER INSTALLATION
"S" TYPE, 3Ø METER ENCLOSURES
OUTDOOR TERMINAL CABINET INSTALLATION

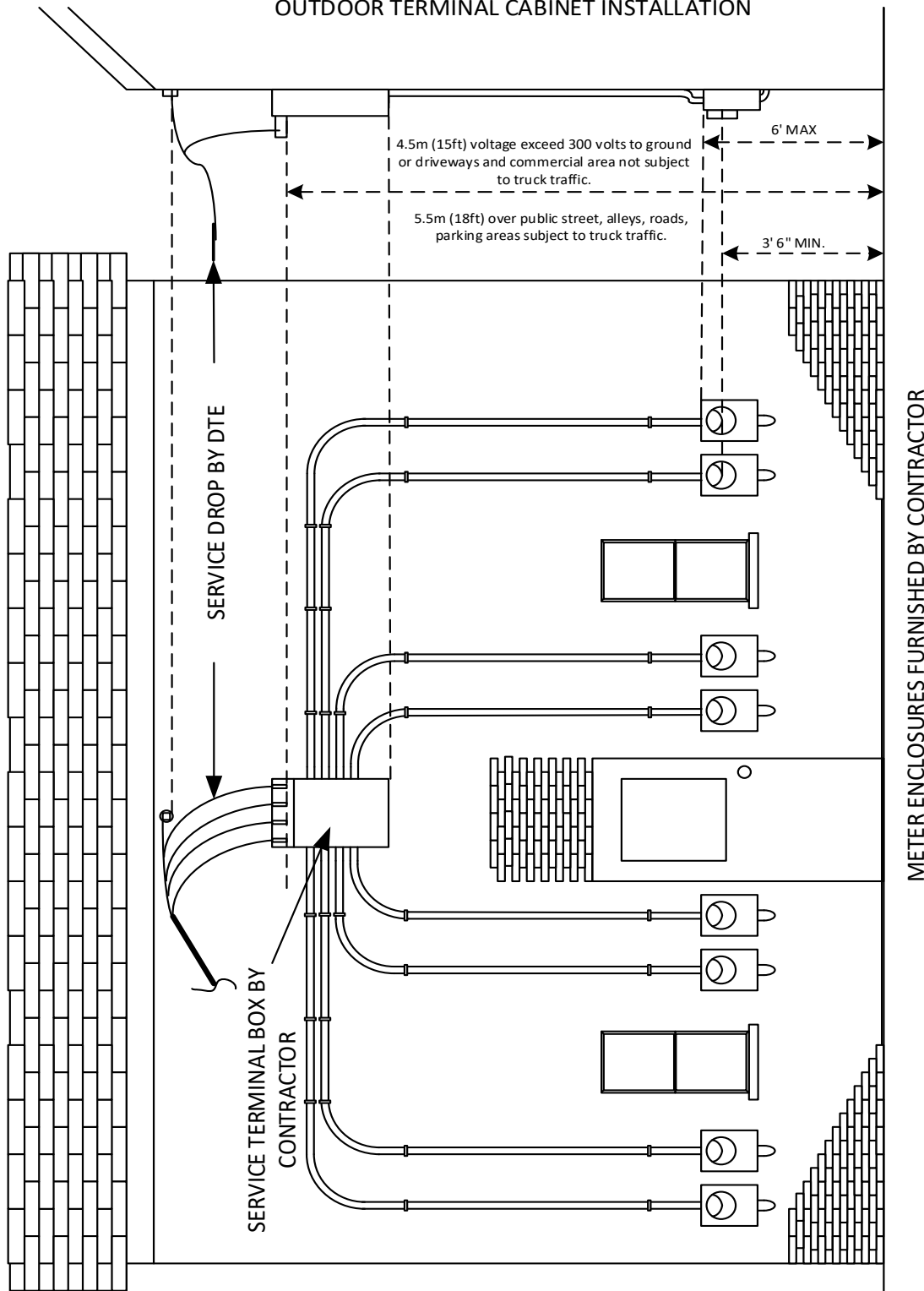

METER ENCLOSURES FURNISHED BY CONTRACTOR

THE DTE ELECTRIC COMPANY ASSUMES NO RESPONSIBILITY FOR INJURY OR DAMAGE ARISING OUT OF THE USE OF THIS SPECIFICATION DIAGRAM.

MULTIPLE METER INSTALLATION

"S" TYPE, 3Ø METER ENCLOSURES

OUTDOOR TROUGH INSTALLATION

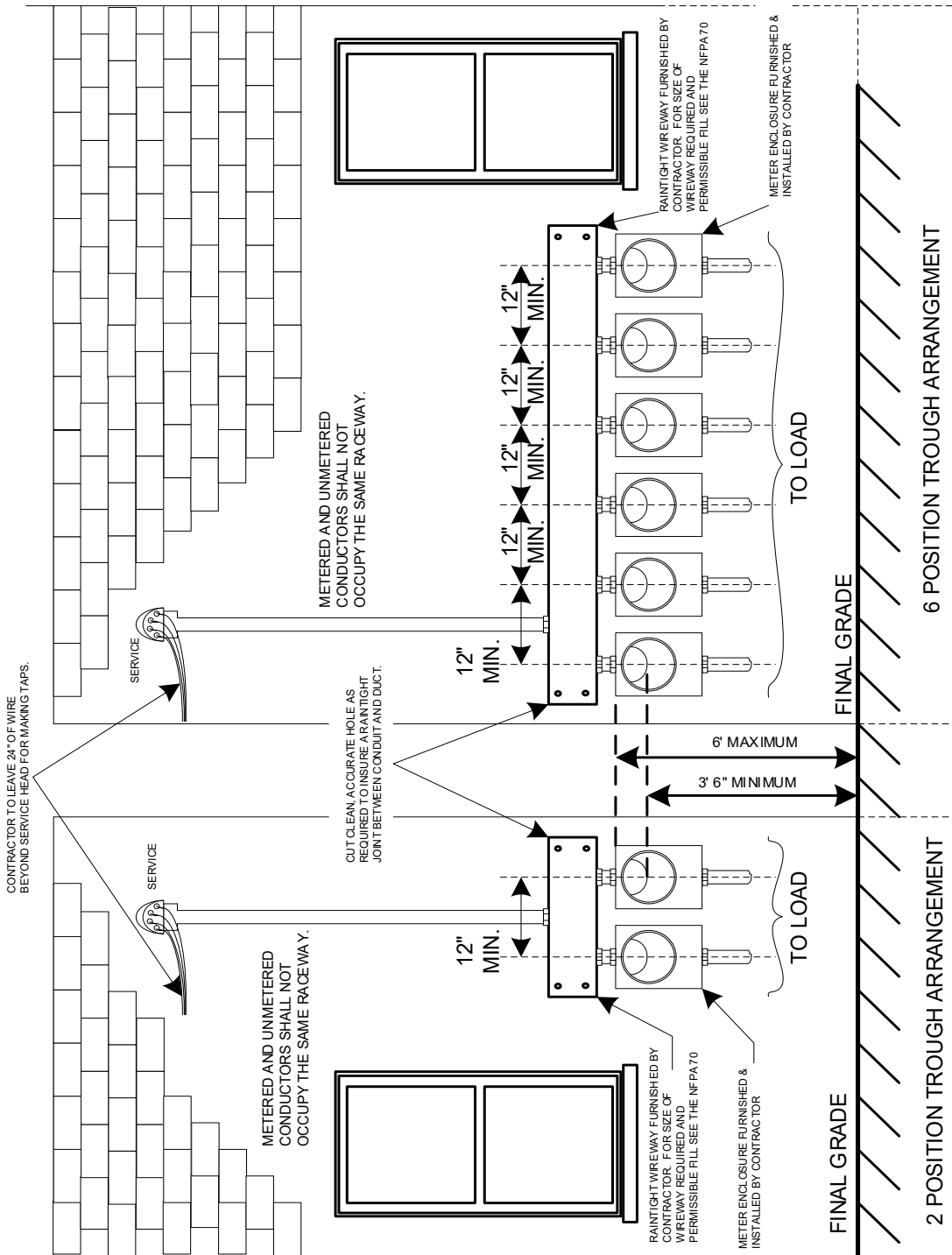

- NOTES:**
- 1-CHECK WITH LOCAL INSPECTION AUTHORITY WHEN MORE THAN SIX SETS OF SERVICE DISCONNECTING AND OVERCURRENT PROTECTION DEVICES ARE REQUIRED.
 - 2-COVERS OF ALL ENCLOSURES SUCH AS WIREWAYS, PULLBOXES AND SWITCH OR CIRCUIT BREAKER CABINETS CONTAINING CONDUCTORS CARRYING UNMETERED CURRENT SHALL BE EQUIPPED WITH APPROVED SEALING DEVICES.
 - 3-SEE INSTALLATION INSTRUCTIONS THIS SECTION.

THE DETROIT EDISON COMPANY ASSUMES NO RESPONSIBILITY FOR INJURY OR DAMAGE ARISING FROM THE USE OF THIS SPECIFICATION DIAGRAM.

MULTIPLE METER ENCLOSURES

3 PHASE INDOOR INSTALLATION

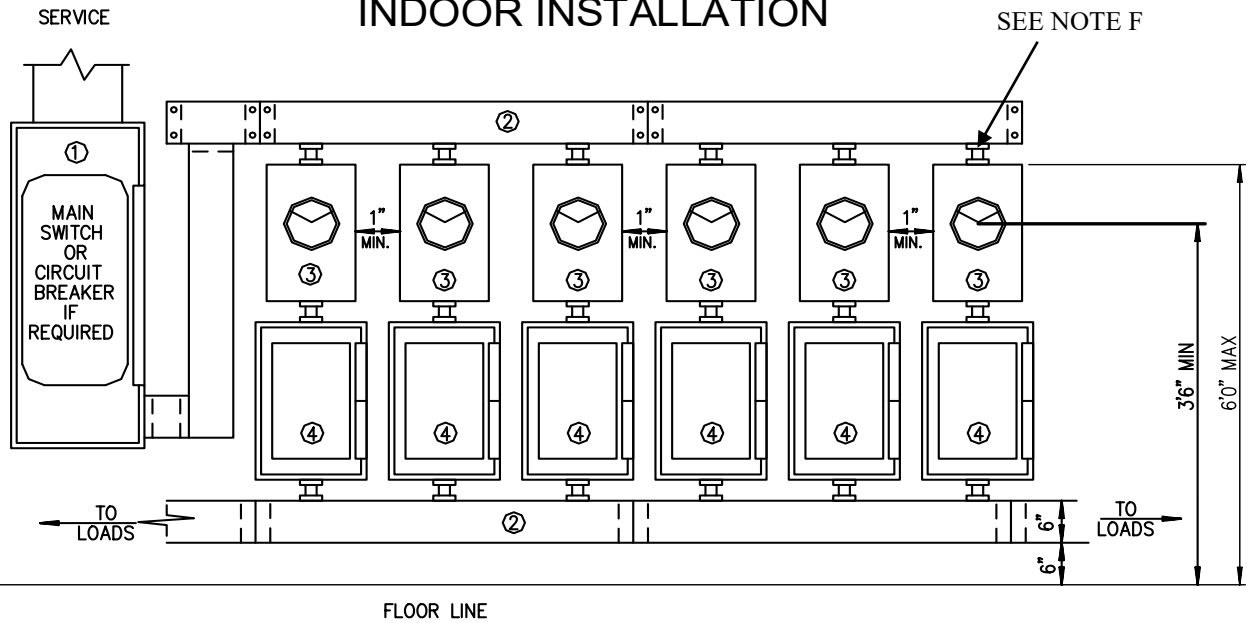

SEE INSTALLATION INSTRUCTIONS THIS SECTION

LEGEND:

1. SWITCH OR CIRCUIT BREAKER FURNISHED AND INSTALLED BY CONTRACTOR.
2. WIREWAY FURNISHED AND INSTALLED BY CONTRACTOR.
3. METER ENCLOSURE FURNISHED AND INSTALLED BY CONTRACTOR.
4. APT. MAIN DISCONNECT FURNISHED AND INSTALLED BY CONTRACTOR.

NOTES:

- A. COVERS OF ALL ENCLOSURES CONTAINING CONDUCTORS CARRYING UNMETERED CURRENT SHALL BE EQUIPPED WITH APPROVED SEALING DEVICES.
- B. METER ENCLOSURES AND DISCONNECTING AND OVERCURRENT PROTECTION DEVICES LOCATED OUTSIDE THE AREA WHERE THE SERVICE ENTERS THE BUILDING SHALL HAVE INSULATED NEUTRAL AND NEUTRAL CONNECTIONS IN ACCORDANCE WITH CODE REQUIREMENTS.
- C. METER ENCLOSURES MUST BE MOUNTED WITH SIDES AND FRONT FACE VERTICALLY PLUMB.
- D. SEE INSTALLATION INSTRUCTIONS THIS SECTION.
- E. METERED AND UNMETERED CONDUCTORS SHALL NOT OCCUPY THE SAME RACEWAY.
- F. ANY BOND BETWEEN THE METER ENCLOSURE AND JOINT USERS THAT INTERFERES WITH REMOVING THE COVER ON THE METER BOX IS A VIOLATION OF NEC 250.94 (A)(3). THE JOINT USER WHO CREATED THE VIOLATION MUST CORRECT THE SITUATION.

DTE ELECTRIC COMPANY ASSUMES NO RESPONSIBILITY FOR INJURY OR DAMAGE ARISING FROM THE USE OF THIS SPECIFICATION DIAGRAM.

THREE-PHASE SELF-CONTAINED
Meter Inspection and Installation Routine

Page 1 of 3

Inspection Date Wanted _____

Address _____ Bldg _____ Fl _____ Apt/Rm _____ City/Town _____

Customer _____ Contractor _____

Planner _____ Telephone _____

Remarks _____

Inspector _____ Date Inspected _____

Remarks _____

1. Address marked on stationary portion of meter enclosure Yes No
2. Safe and permanent access to metering equipment Yes No
3. **Working clearances** in front of meter enclosure:
min. 30" wide by 36" deep (min. 30" wide by 48" deep for 480 V) Yes No
4. Access clearances to meter enclosure:
min. 24" wide by 6' 6" high and clear of obstructions Yes No
5. Customer's service disconnect installed Yes No
6. Grounding electrode conductor installed and connected to
Grounding Electrode System (NEC) Yes No
Not to be routed through or terminated in meter enclosure
7. Check for correct voltages No check Yes No

THREE-PHASE SELF-CONTAINED
Meter Inspection and Installation Routine

Page 2 of 3

- 8. Correct meter enclosure installed (3Ø, CL200)..... Yes No
- 9. Power leg in correct position N/A* Yes No
Right-hand position in socket enclosures
Center position in B-base enclosures
- 10. Line and load wires enter enclosure at approved locations Yes No
- 11. Any backfeed on line or load conductors No check Yes No
- 12. Any faults in line or load conductors..... No check Yes No
- 13. Was enclosure jumpered..... Yes No
- 14. Service entrance conduit type Metallic PVC (electrical)
- 15. Service conduit properly sized and supported Yes No
- 16. Weatherhead or gooseneck min. 6" *above* attachment point N/A* Yes No
- 17. Busbar min. 18" *below* attachment point (30" preferred) N/A* Yes No
- 18. Service conductors extend min. 24" from weatherhead N/A* Yes No
- 19. Service entrance conductors identified Yes No
- 20. Point of attachment to finished grade minimums met N/A* Yes No
Residential -- drip loop-10', driveway-12', street-18', hwy-22'
Commercial -- drip loop-12', bus-15', vehicular traffic-18', hwy-22'
- 21. Meter enclosure securely fastened with sides and face vertically plumb Yes No
- 22. Meter enclosure height max. 6' to top, min. 3' 6" to center of meter face Yes No

N/A* *Not Applicable*

THREE-PHASE SELF-CONTAINED
Meter Inspection and Installation Routine

Page 3 of 3

23. Meter enclosure min. 1-foot horizontal clearance from inside corner..... Yes No
24. The edge of any metal or PVC terminal adapter, connector, or nipple entering meter box or tap box is covered with a nonmetallic bushing Yes No
25. Inspect meter enclosure for sealing hasp, openings sealed, block cond., etc. Yes No
26. Inspect and tighten all line, load, and neutral connections Yes No
27. Inspect for insulated neutral requirements (See 5-1-3 #10 (d))..... Yes No
28. Install meter and seal enclosure Yes No
29. Place *underground service* label on meter enclosure N/A* Yes No
30. Place *480 V* label on meter enclosure and main disconnect N/A* Yes No

N/A* *Not Applicable*

Commercial Metering Switchboard
Installation Routine 277/480V

Page 1 of 2

Inspection Date Wanted _____

Address _____ Bldg _____ Fl _____ Apt/Rm _____ City/Town _____

Customer _____ Contractor _____

Planner _____ Telephone _____

Remarks _____

Inspector _____ Date Inspected _____

Remarks _____

1. Address marked on stationary portion of meter enclosure Yes No
2. Enclosure door marked to identify internal equipment..... Yes No
3. Safe and permanent access to metering equipment Yes No
4. **Working clearances** in front of switchboard and meters:
min. 30" wide by 48" deep..... Yes No
5. Workspace permits at least a 90° opening of compartment door(s)..... Yes No
6. Access clearances to meter enclosure and switchboard:
min. 24" wide by 6' 6" high and clear of obstructions Yes No
7. Grounding electrode conductor installed and connected to
Grounding Electrode System (NEC) Yes No
8. DTE approved switchboard manufacturer Yes No

Commercial Metering Switchboard
Installation Routine 277/480V

Page 2 of 2

- 9. Barriers in switchboard compartment separating metering area from adjacent areas Yes No
- 10. Switchboard main disconnect size per manufacturer spec Yes No
- 11. One conductor of each phase and one neutral in each Switchboard line side conduit, when conduit fed..... Yes No
A separate grounding conductor (green wire) should not be installed in the service conduits.
- 12. Outdoor weathertight equipment construction..... N/A* Yes No
- 13. Line conductors identified in switchboard compartment..... Yes No
- 14. Power leg at *center* bus position N/A* Yes No
- 15. Any back feed on line or load conductors N/A* Yes No
- 16. Service entrance conduit type..... Metallic PVC (electrical) Pre-fab. Bus
- 17. Service conduit properly sized and supported N/A* Yes No
- 18. There are no unused metering positions Yes No
- 19. Meter sockets are DTE approved..... Yes No

N/A* *Not Applicable*

CURRENT TRANSFORMER CABINETS

1. Services Exceeding 200 Amperes.

Current transformers shall be used to meter Underground and Overhead Single-Phase commercial and residential services that exceed the capacity of a class 320 enclosure. All Three-Phase services that exceed the capacity of a class 200 enclosure are required to use or shall be converted to current transformers. Current transformer cabinets will generally be used for cable services from 250 kcmil through 500 kcmil and for bus head services up to and including 1000 amperes. Transockets are a combination of meter socket and current transformer cabinet and its application is limited to 400A.

2. Services Exceeding 1000 Amperes.

Services greater than 1000 amperes will use a switchboard for service entrance equipment with a current transformer section for metering.

3. Building Owner Responsibilities.

The customer's contractor will furnish and install the current transformer cabinet. The customer's contractor will install line and load side cable on **commercial** CT cabinet installations.

The meter will be installed by DTE Electric in a current transformer rated meter enclosure furnished by and installed by the customer's contractor. The enclosure must be approved by DTE Electric, UL Listed and Labeled.

(For installation diagrams see pages 5-4-9 and 5-4-10.)

4. Equipment Grouping.

Indoor installations must have the meter enclosure and current transformer cabinet in the same room. Outdoor installations will have both units outside. The meter enclosure may be located on either side, above, or below the current transformer cabinet providing that proper clearance to grade or floor can be maintained. (See page 5-3-2.) The meter-wiring conduit will be trade size 1-1/4 inch *metal*. **PVC is not permitted.**

5. Equipment Access.

A current transformer cabinet and meter installed on a balcony, mezzanine, second floor, or above grade platform requires access by permanent stairway. *Ladder access for reading and testing meters is not acceptable.* The DTE Energy Planner must approve the installation of a current transformer cabinet on a balcony, mezzanine, or second floor with the meter enclosure located at floor or grade level. Access and working space must comply with 2023 NEC 110.26, *Spaces About Electrical Equipment*.

6. Equipment Use.

The line terminals on a current transformer cabinet will be used for service entrance conductors only. A terminal box (aka tap box) is preferred for grouped meter connections except to feed separately metered space conditioning, water heating, or electric vehicle charging station as shown in Section 7. In unusual cases, the DTE Energy Planner may grant an exception.

7. Equipment Relocation.

If the metering point is relocated, the existing current transformer cabinet can be left in place and used as a junction box providing the following procedure is followed:

- (a) The customer's contractor must furnish and install the required jumper bars.
- (b) The customer's contractor is responsible for keeping the customer in service during the cutover of circuits.
- (c) The customer's contractor must furnish and install the new current transformer cabinet subject to DTE Energy specifications and approval.

8. Acceptable Current Transformer Cabinets and Transockets.

8.1 The following current transformer cabinets have been accepted for use in the DTE Energy Service Area. Manufacturers desiring to have their equipment listed may contact DTE Energy Meter Engineering 313 389-7711.

- (a) *Electrical Power Products*, 2611 Elliott Ave., Troy, MI 48083, 248.583.6100
- (b) *Park Metal Product*, 19197 Sherwood, Detroit, MI 48234, 313.366.2200, <http://www.parkdetroit.com/>
- (c) *Continental Electrical Products* by Cotson Fabricating, 1005 Troy Ct, Troy, MI 48083, 248.589.2758, <http://www.continentalelectricalproducts.com/>

8.2 Approved Transockets are limited to 400A.

<i>Service Type</i>	<i>Manufacturer</i>	<i>Cat#</i>	<i>Notes</i>
3 Phase 4 Wire	Milbank	U5944-XT-181	N/A

CURRENT TRANSFORMER INSTALLATIONS**1. Ordering Routine.**

Following a satisfactory installation inspection, the Planner will order the installation of the meter and the current transformers (CTs) by issuing a Request for Work (RFW) number with a Meter Installation (MIC) job assigned to the appropriate Field Operations (FO) Supervisor / Field Service Automation (FSA).

The following information must be entered on the Job Meter Info screen:

- (a) Number of CTs
- (b) CT ratio
- (c) Service voltage and phase (e.g. 120/240V 3Ø 4W-D)
- (d) ___ feet of meter conduit
- (e) Meter type
- (f) Attached demand (if a combination watt-hour and demand display is required)
- (g) Meter location
- (h) Demand load in kW

Note: *Be sure to indicate in the MIC job notes the number of bus bars per phase on free standing switchboards. These should be noted if a 6-foot ladder is needed or if a key address is necessary.*

2. Table of Bar Type Current Transformers.

<u>MMS Stock No.</u>	<u>Metering Ratio</u>	<u>Current Ratio</u>	<u>Nameplate Rating</u>
200000655	80:1	400:5	400 amps
200000970	160:1	800:5	800 amps
200000911	240:1	1200:5	1200 amps
200000957	400:1	2000:5	2000 amps
641-6043	600:1	3000:5	3000 amps

- Notes: (a) Maximum size for a CT cabinet is 160:1.
(b) 240:1 and larger CTs have multiple bus bars.

Planners will always size current transformers for the expected maximum *demand* load in amperes (see pages 12-2-6 and 12-2-7). Do not exceed nameplate rating.

3. Service Changes.

This includes increases and decreases in ampacity, single-phase to three-phase, and three-phase to single-phase conversions. It does not include changes in service location. Electric Field Operations (EFO) will decide if the service factors will allow existing CTs to be used. All CTs must be the same size and type.

The following information must be entered on the Job Meter Info screen:

- (a) New demand load in amperes
- (b) Meter number
- (c) CT ratio
- (d) Service voltage and phase
- (e) Present meter type
- (f) Attached demand
- (g) Demand in kW
- (h) Meter location
- (i) Transocket

CURRENT TRANSFORMER CABINET FABRICATION STANDARDS

1. Minimum distance between live-parts that are not of the same phase is two inches. Ampacity of bare copper bus is 1000 amperes per square inch of cross-sectional area (thickness x width). Ampacity of aluminum bus is 700 amperes per square inch. Minimum bus bar thickness is 1/4 inch. (See 2023 NEC 366.23 *Ampacity of Conductors*.)
2. Fabrication must be weather resistant for either indoor or outdoor installations. National Electrical Manufacturers Association (NEMA) Type 3R.
3. Cabinets must have an acceptable sealing hasp or three-point latch.
4. Handles shall be installed on both sides to provide a grip for the meter installer.
5. 7/16"-14 jumpering studs must be provided for jumper installation on future current transformer changes.
6. Cabinets shall be metallic with a minimum wall thickness of #14 Metal U.S. Manufacturers' Standard Gage (MSG). 2023 NEC 312.100 (B) *Strength*, "If constructed of sheet steel, the metal thickness shall not be less than 1.35 mm (0.053 in.) uncoated."
7. The cabinet must have a minimum of one inch airspace between any wall, back, metal partition or door and any current-carrying part of the inside of the cabinet. (See 2023 NEC 312.101 *Spacing, (A)(3) Live Parts*.)
8. All exposed edges of cabinets shall be rounded.
9. At a minimum, all cabinets must meet all specifications and requirements of 2023 NEC Article 312, Cabinets, Cutout Boxes, and Meter Socket Enclosures.
10. Minimum inside dimensions are 48" high, 24" wide and 10" deep.
11. Cabinets must be corrosion resistant both inside and outside. [See 2023 NEC 312.100(A).]
12. Refer to current transformer cabinet bus bar details SIM-ESIG Page 5-6-7.
13. Bus termination points must meet minimum bending space requirements for any conductor used. For installations exceeding 800 amperes, 3 conductors per phase may be required. In some cases, cabinet extensions or an increase in cabinet size may be necessary to meet bending space requirements. For required minimums see 2023 NEC, Table 312.6(A), *Minimum Wire-bending Space at Terminals and Minimum Width of Wiring Gutters*.
14. Terminal connectors must be UL listed for the size and type of conductors used.
15. All cabinets will be marked **TOP ONLY** with 1" high letters on inside back of cabinet.

The DTE Electric Company assumes no responsibility for injury or damage arising from the use of these specifications.

MINIMUM SPECIFICATIONS FOR CUSTOMER OWNED
CURRENT TRANSFORMER CABINETS

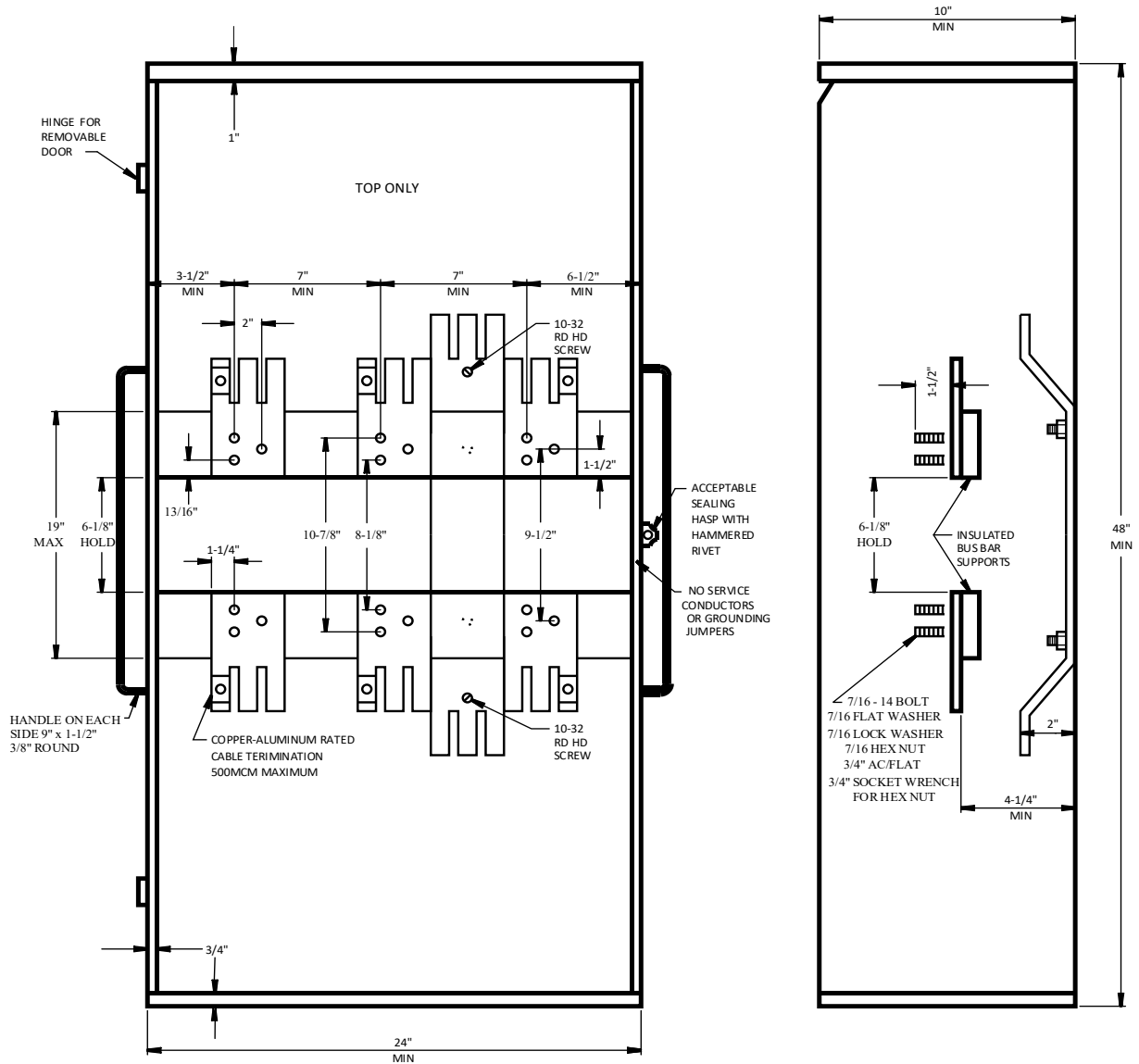

NOTES:

1. SEE PAGE 5-4-5 FOR GENERAL NOTES ON CURRENT TRANSFORMER CABINET.
2. UNIT MUST BE UL LISTED. LABELS MUST ALSO IDENTIFY MODEL NUMBER AND RATINGS.

THE DTE ELECTRIC COMPANY ASSUMES NO RESPONSIBILITY FOR INJURY OR DAMAGE ARISING FROM THE USE OF THIS SPECIFICATION DIAGRAM

**CURRENT TRANSFORMER / TRANSOCKET CABINET
INSTALLATION STANDARDS**

*Not all below apply for Transocket

The building owner is responsible for the selection, purchase, installation, and maintenance of the current transformer cabinet. All installations must meet the following DTE Electric specifications:

1. The 1-1/4 inch *metal* conduit that feeds the meter enclosure must not interfere with the bus bars or the current transformers.
2. The 1-1/4 inch metal conduit between the meter enclosure and the CT cabinet must not be longer than 20 feet or shorter than 3 inches. The conduit may only enter the meter enclosure as specified on page 5-3-19.1, and the CT cabinet through the top, bottom, or sides (including between the CT mounting supports).
3. The meter enclosure must be mounted plumb with a minimum height of 42 inches from the center of the meter to finished grade and a maximum height of 6 feet to the top of the enclosure. Door mounting of the meter enclosure will be permitted *only* when no space is available within the area to allow connection with a 20 foot 1-1/4 inch conduit run. Must be preapproved by DTE Electric Planner.
4. The current transformer cabinet shall be installed a minimum of 6 inches above the floor indoors or 18 inches above grade outdoors. Maximum mounting height is 9 feet from floor or grade to a point midway between the current transformer terminal boards.
5. No service or load conduit or conductors shall enter into or pass through the cabinet between the CT mounting supports. One conductor of each phase and one neutral shall be installed in each line conduit. Rear entrance is acceptable on 48-inch high cabinets.
6. On a 4-wire, delta-connected service where the midpoint of one phase is grounded, the phase conductor having the higher voltage to ground shall be durably and permanently marked by an outer finish that is *orange* in color. (See 2023 NEC 110.15 *High-Leg Marking*.)
7. The center phase must be the power leg on a 3-phase, 4-wire delta connected service. (See 2023 NEC 408.3 (E), *Bus Arrangement*.)
8. The center phase position will not be used on a single-phase installation.
9. Jumpers installed by contractors must be trained as shown in drawing on page 5-4-8 for CT cabinets and on page 5-4-20 for Transocket cabinets so that current transformers can be installed with jumpers in place.
10. Contractor is responsible for marking on the inside of the cabinet the word **LINE** to identify the incoming Line (Utility) conductors.

DTE assumes no responsibility for injury or damage arising from the use of these specifications.

TYPICAL OVERHEAD CURRENT TRANSFORMER
CABINET INSTALLATION

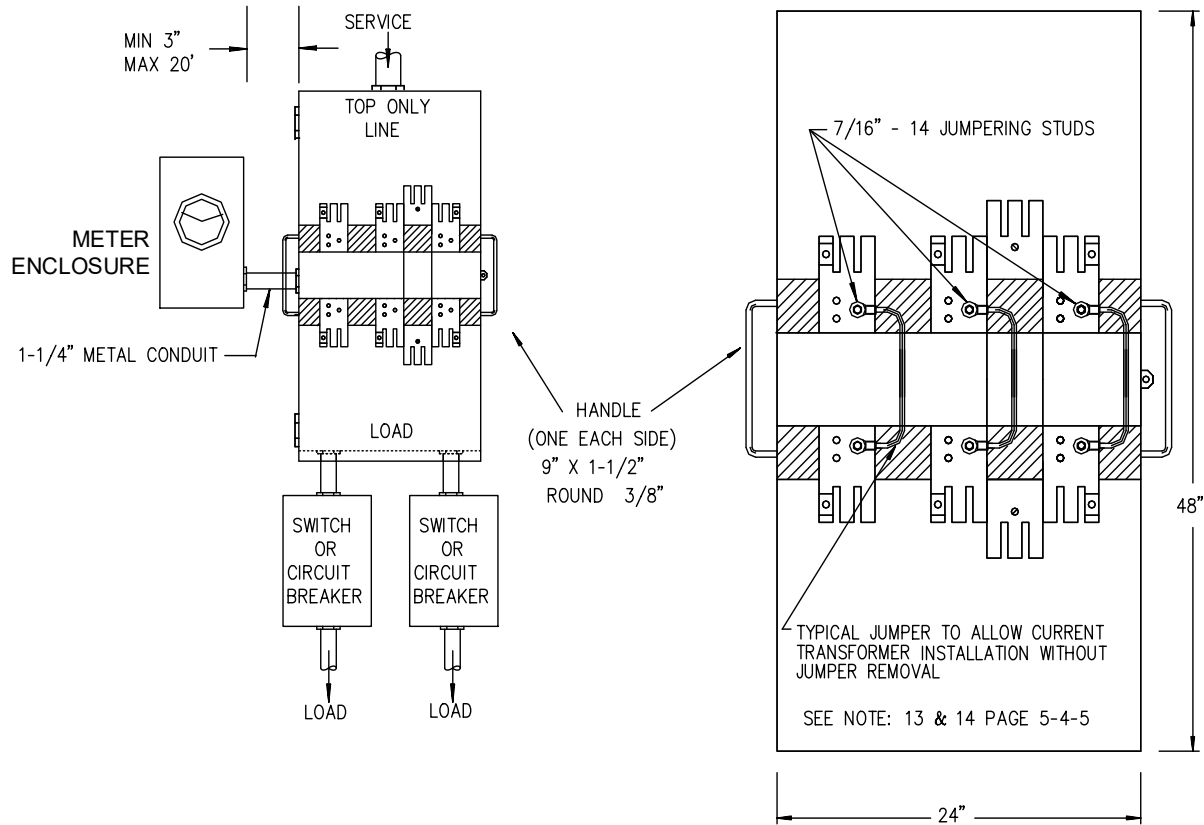

TYPICAL UNDERGROUND CURRENT TRANSFORMER
CABINET INSTALLATION

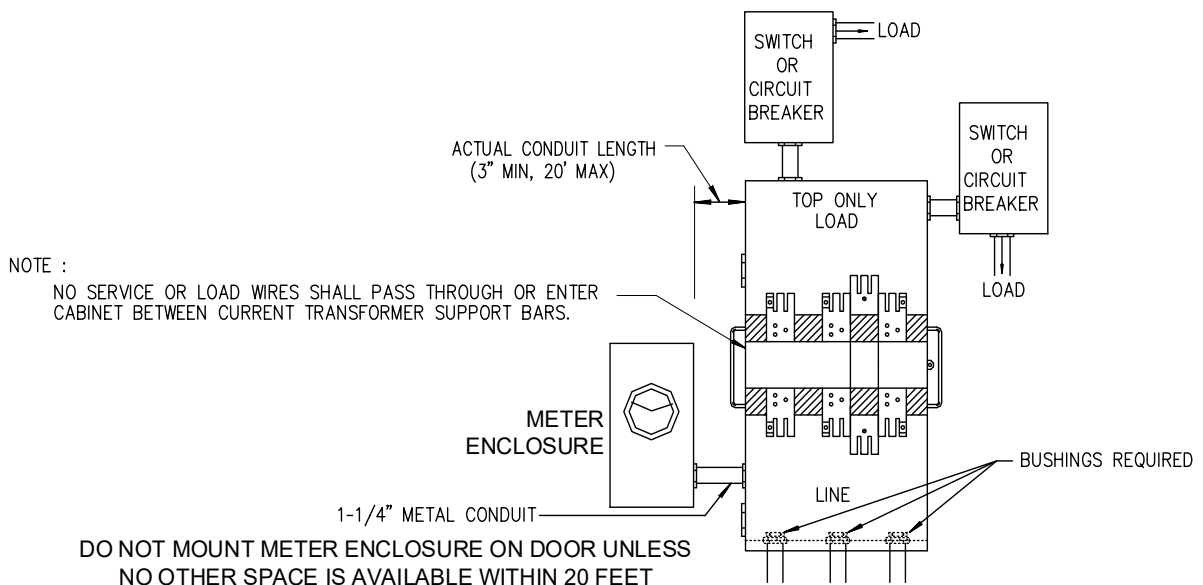

NOTE:
SEE INSTALLATION INSTRUCTIONS ON 5-4-7.

DTE assumes no responsibility for injury or damage arising from the use of these specifications.

OVERHEAD BUS BAR SERVICE
CURRENT TRANSFORMER CABINET INSTALLATION

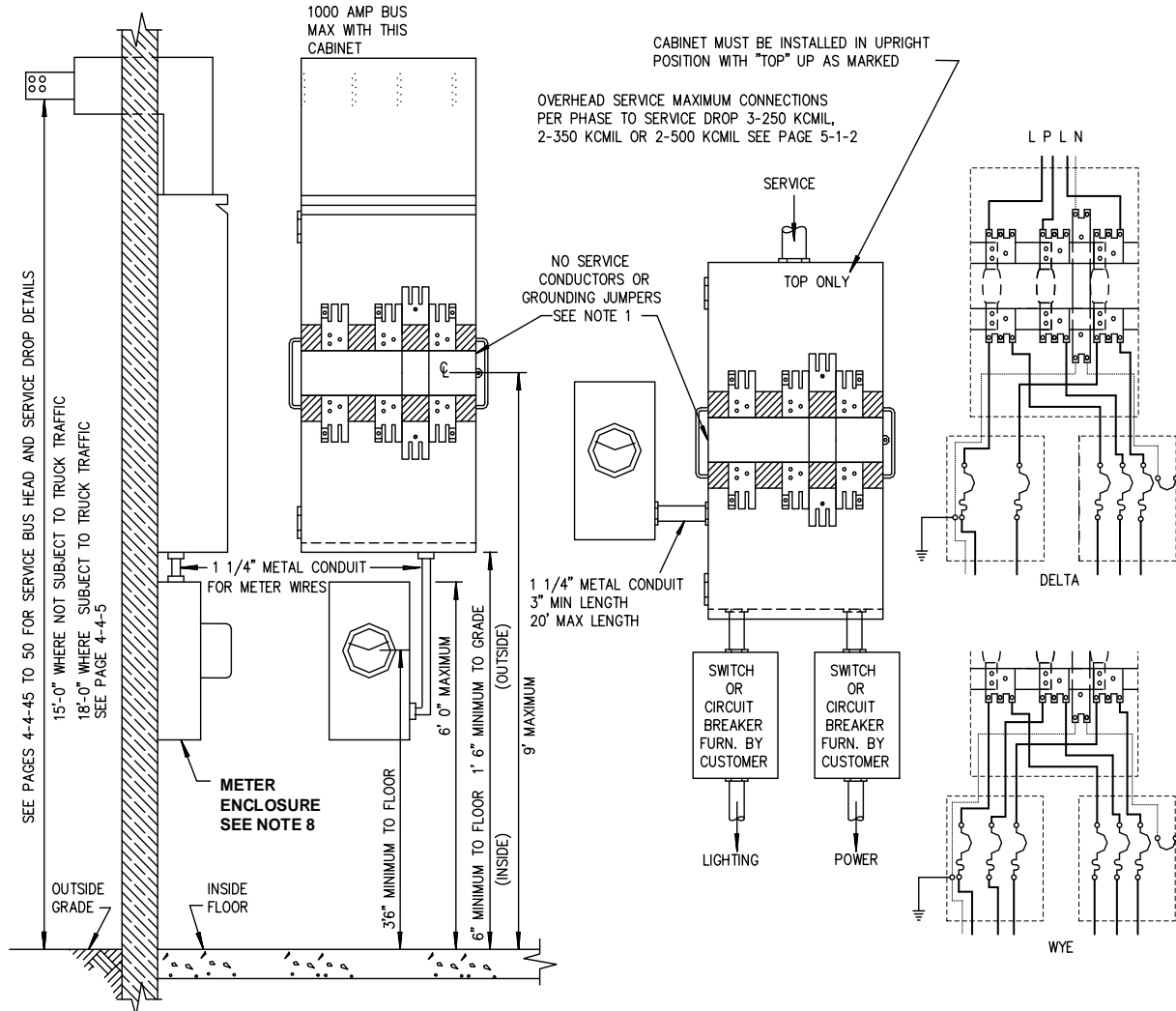

1. SERVICE CONDUIT MAY ENTER CURRENT TRANSFORMER CABINET FROM TOP, BACK, BOTTOM OR SIDES. NO SERVICE CONDUIT SHALL ENTER CABINET BETWEEN CURRENT TRANSFORMER TERMINAL BOARDS. NO SERVICE CONDUCTORS OR GROUNDING JUMPERS ARE ALLOWED BEHIND, IN FRONT OR THROUGH CURRENT TRANSFORMER MOUNTING AREA BETWEEN LINE AND LOAD BUS BARS.
2. SEE PAGES 5-4-10 AND 5-6-5 FOR BUS BAR SERVICE DETAILS.
3. METER ENCLOSURES SHALL BE SECURELY FASTENED TO WALL USING SCREWS, ANCHOR BOLTS, TOGGLE BOLTS OR OTHER MEANS APPROVED BY THE DECO.

METAL CONDUIT FOR METER WIRES MAY ENTER THE METER ENCLOSURE AS SHOWN ON 5-3-19.1.
5. ON THREE PHASE DELTA SERVICE THE CENTER TERMINAL SHALL BE CONNECTED TO THE POWER WIRE (208 VOLTS TO GROUND). THE CENTER TERMINAL WILL NOT BE USED ON A SINGLE PHASE INSTALLATION.
6. POWER LEG IDENTIFICATION PER 2023 N.E.C. 110.15, 230.56 AND 408.3(E) & (F).
7. CURRENT TRANSFORMER CABINET SHALL BE INSTALLED A MINIMUM DISTANCE OF 6" ABOVE FLOOR OR 18" MINIMUM ABOVE OUTDOOR GRADE. MAXIMUM MOUNTING HEIGHT ABOVE FLOOR OR OUTDOOR GRADE IS 9' TO CENTER OF CURRENT TRANSFORMER MOUNTING SECTION. MINIMUM HEIGHT OF BUS BAR AT SERVICE IS 15'.
8. ANY BOND BETWEEN THE METER ENCLOSURE AND JOINT USERS THAT INTERFERES WITH REMOVING THE COVER ON THE METER BOX IS A VIOLATION OF NEC 250.94 (3). THE JOINT USER WHO CREATED THE VIOLATION MUST CORRECT THE SITUATION.

DTE ELECTRIC COMPANY ASSUMES NO RESPONSIBILITY FOR INJURY OR DAMAGE ARISING FROM THE USE OF THIS SPECIFICATION DIAGRAM.

CLEARANCE REQUIREMENTS FOR METER BOX AND CURRENT TRANSFORMER INSTALLATIONS

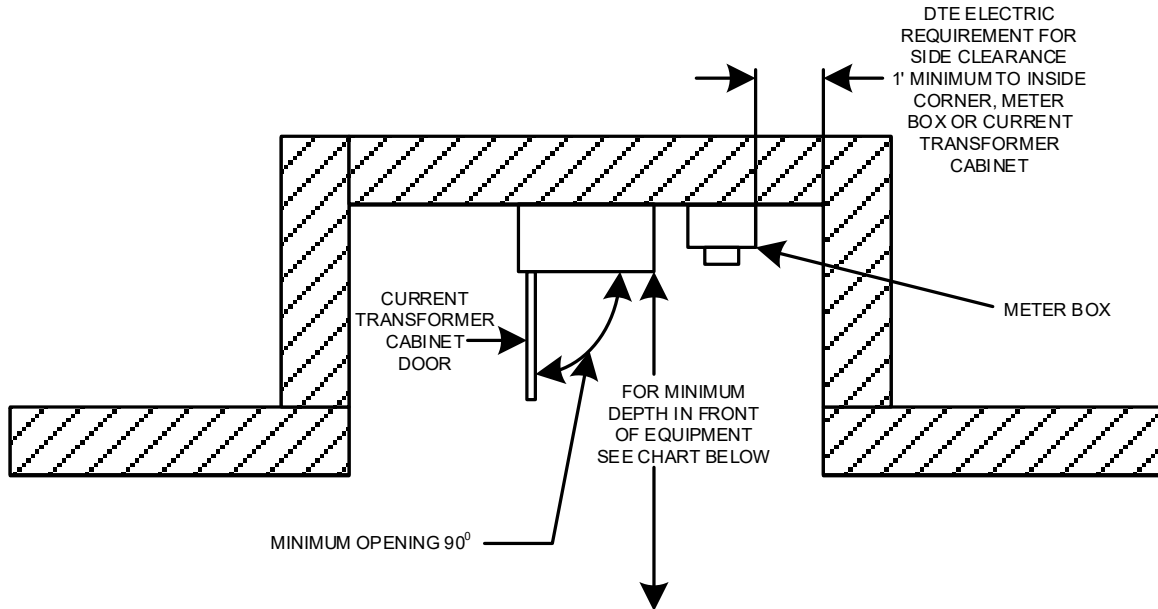

30" MINIMUM CLEARANCE WIDTH FOR WORKING SPACE IN FRONT OF METER AND CURRENT TRANSFORMER CABINET

MINIMUM WORKING SPACE PER NFPA 70
2023 NEC TABLE 110.26(A)(1) WORKING SPACE

MINIMUM CLEARANCE DEPTH IN FRONT OF EQUIPMENT		
CONDITIONS	0-150V	151-600V
1 INSULATED WALL IN FRONT OF EQUIPMENT	3'	3'
2 WALL IN FRONT OF EQUIPMENT GROUNDED TO EARTH	3'	3 1/2'
3 EDISON METERING EQUIPMENT ACROSS FROM OTHER EQUIPMENT WITH EXPOSED LIVE PARTS	3'	4'
4 LADDER REQUIRED TO REACH CURRENT TRANSFORMER COMPARTMENT FOR INSTALLATION	5'	5'

THESE DIMENSIONS ARE FOR INDOOR OR OUTDOOR INSTALLATIONS

THE DTE ELECTRIC COMPANY ASSUMES NO RESPONSIBILITY FOR INJURY OR DAMAGE ARISING FROM THE USE OF THIS SPECIFICATION DIAGRAM.

BUS BAR SERVICE DETAILS – AMPERE CAPACITY CURRENT TRANSFORMER CABINET

- NOTES:**
1. ARRANGEMENT OF BUS INSIDE CABINET IS TYPICAL, OTHER ARRANGEMENTS MUST FIRST BE APPROVED BY DTE
 2. FABRICATE DUCT IN ACCORDANCE WITH N.E.M.A. BUSWAY STANDARDS.
 3. ALL DIMENSIONS SHOWN SHALL BE HELD.
 4. ALL BOLTS, NUTS, & SCREWS SHALL BE CADMIUM PLATED, WASHERS SHALL BE GALVANIZED.
 5. BUFFING, BRUSHING OR POLISHING PLATED ALUMINUM WILL REMOVE THE PROTECTIVE PLATE THUS CAUSING UNDUE OXIDATION OF THE ALUMINUM.
 6. ELECTRICAL GRADE COPPER OR ALUMINUM BUSES ARE ACCEPTABLE AS CURRENT CARRYING CONDUCTORS.

BUS SERVICE ENTERS TOP OF CURRENT TRANSFORMER CABINET WHEN NECESSARY TO EXTEND SERVICE HEAD ABOVE CURRENT TRANSFORMER CABINET TO PROVIDE REQUIRED CLEARANCE TO GRADE FOR SERVICE HEAD.

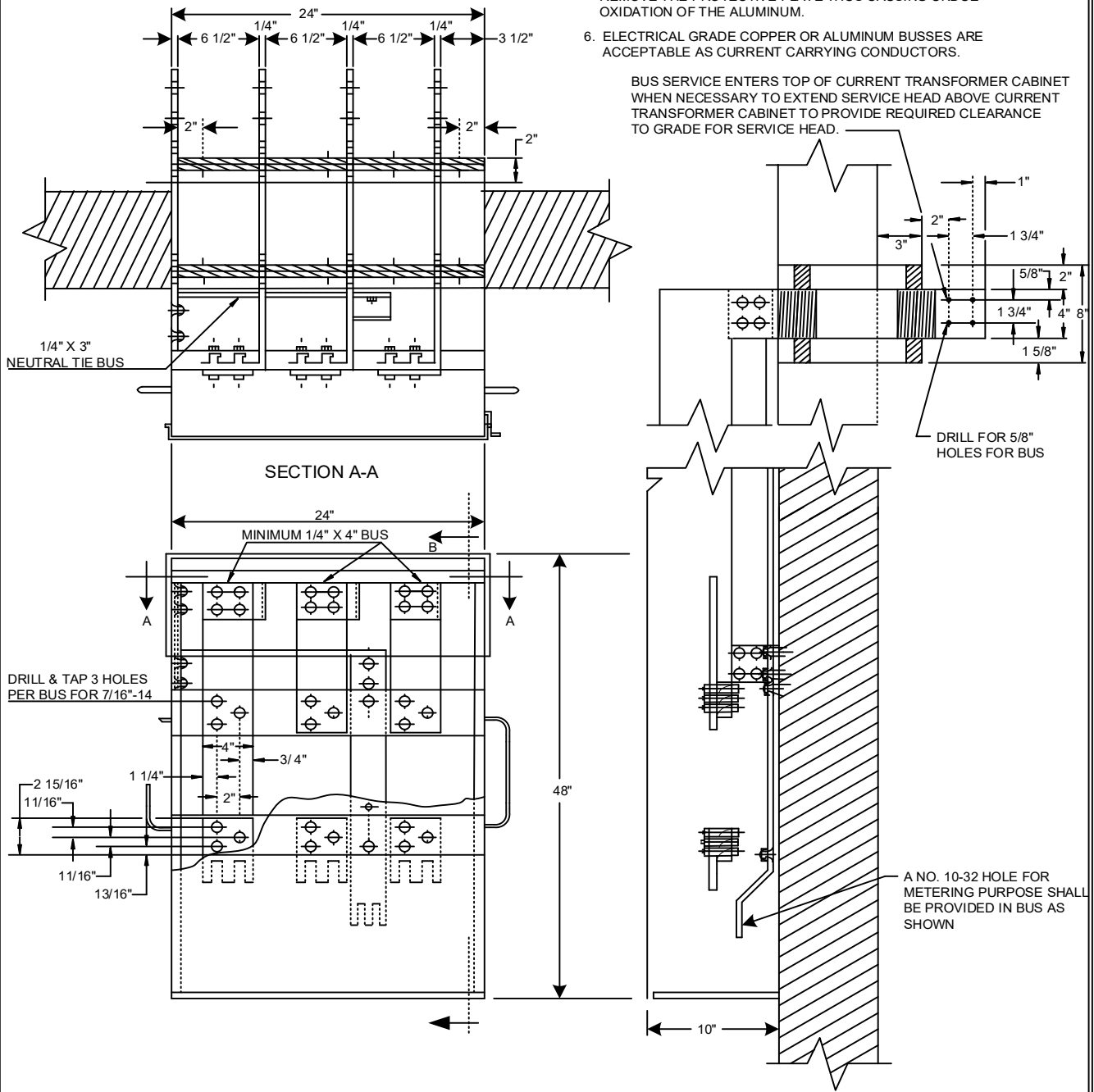

THE DTE ELECTRIC COMPANY ASSUMES NO RESPONSIBILITY FOR INJURY OR DAMAGE ARISING FROM THE USE OF THIS SPECIFICATION DIAGRAM

CURRENT TRANSFORMER CABINET INSTALLATION ONE, TWO OR THREE 250 THRU 500 KCMIL PER PHASE

ANY BOND BETWEEN THE METER ENCLOSURE AND JOINT USERS THAT INTERFERES WITH REMOVING THE COVER ON THE METER BOX IS A VIOLATION OF NEC 250.94 (A)(3). THE JOINT USER WHO CREATED THE VIOLATION MUST CORRECT THE SITUATION.

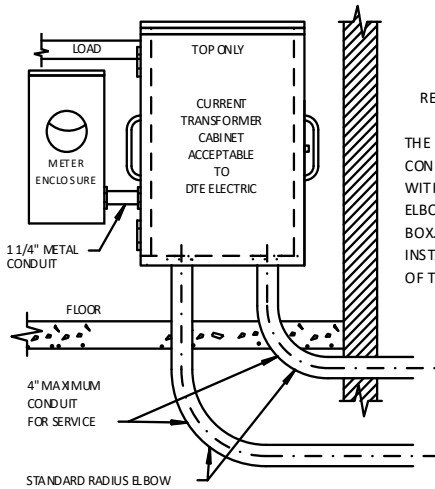

REFER TO 5-4-13 NOTES 2 THROUGH 11

THE INSTALLATION OF 2 SERVICE ENTRANCE CONDUITS, THROUGH A BUILDING WALL, WITHOUT THE USE OF STANDARD RADIUS ELBOWS WILL REQUIRE A SERVICE JUNCTION BOX. THE SERVICE JUNCTION BOX WILL BE INSTALLED EITHER AT THE TOP OR BOTTOM OF THE CURRENT TRANSFORMER CABINET.

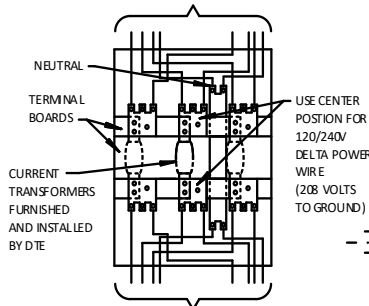
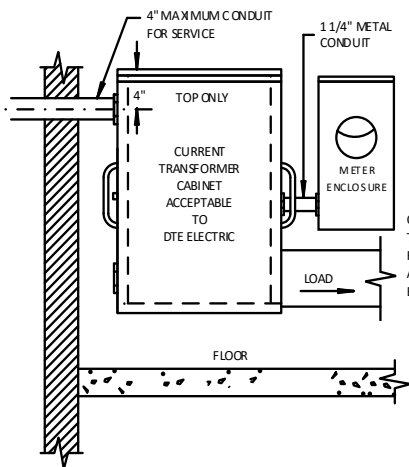
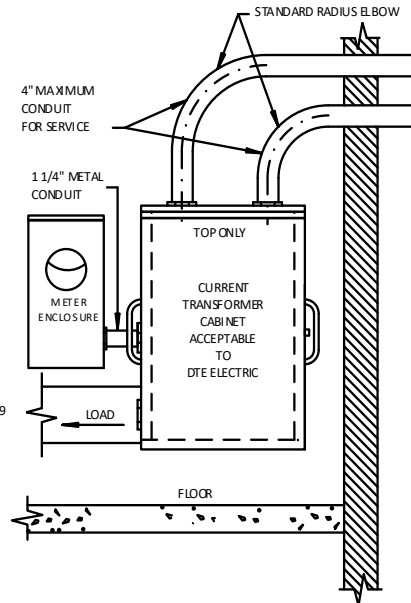
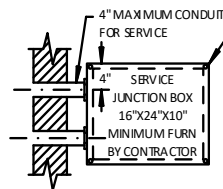

WIRING DIAGRAM

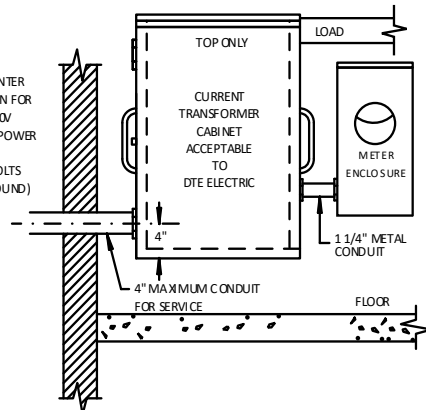

METER ENCLOSURE CAN BE MOUNTED ON EITHER SIDE OF CT CABINET

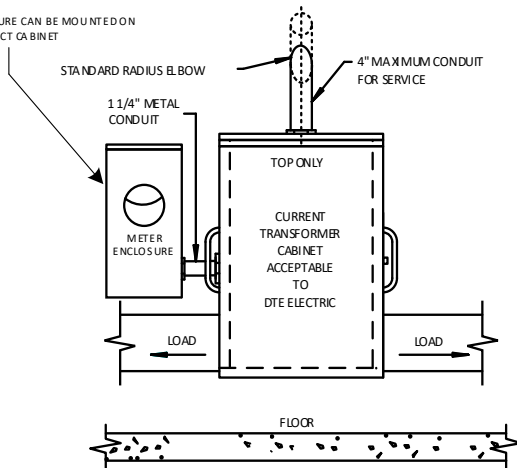

METER ENCLOSURE CAN BE MOUNTED ON EITHER SIDE OF CT CABINET

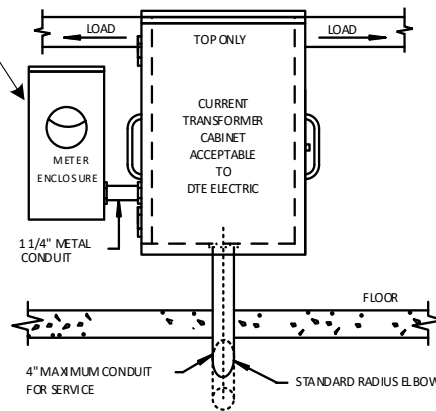

DTE ELECTRIC COMPANY ASSUMES NO RESPONSIBILITY FOR INJURY OR DAMAGE ARISING FROM THE USE OF THIS SPECIFICATION DIAGRAM.

CURRENT TRANSFORMER CABINET INSTALLATION
LOADS GREATER THAN 800 AMPS REQUIRING 3 CONDUCTORS PER PHASE

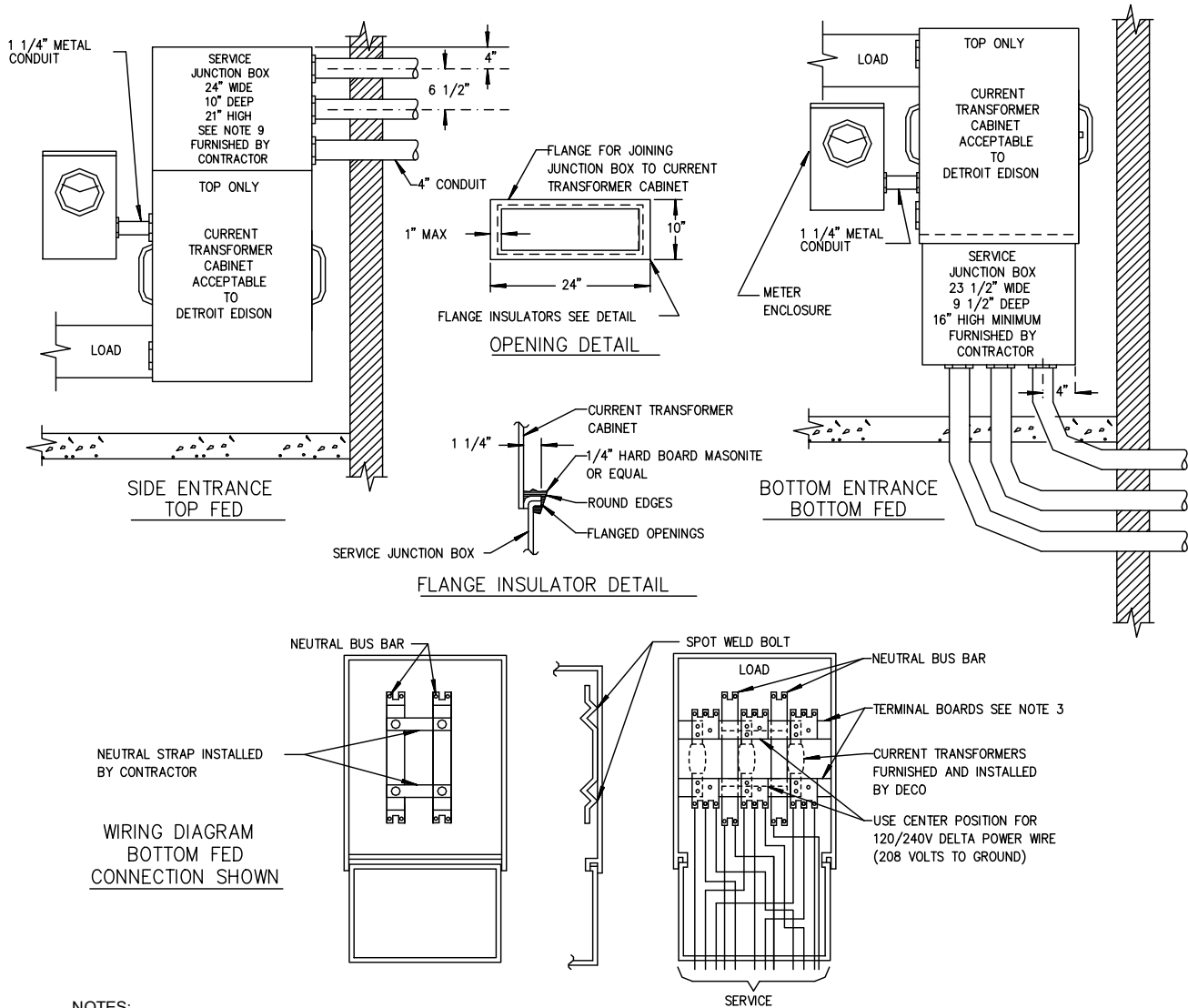

NOTES:

1. FOR LOADS GREATER THAN 800 AMPERES REQUIRING 3 CONDUCTORS PER PHASE A SERVICE JUNCTION BOX MAY BE USED.
2. THE SERVICE JUNCTION BOX MAY BE INSTALLED AT EITHER TOP OR BOTTOM OF THE CURRENT TRANSFORMER CABINET.
3. ONE CONDUCTOR OF EACH PHASE AND ONE NEUTRAL SHALL BE INSTALLED IN EACH CONDUIT.
4. SERVICE CONDUIT MAY ENTER CURRENT TRANSFORMER CABINET FROM TOP, BACK, BOTTOM OR SIDES.
NO SERVICE CONDUIT SHALL ENTER CABINET BETWEEN CURRENT TRANSFORMER TERMINAL BOARDS.
NO SERVICE CONDUCTORS OR GROUNDING JUMPERS ARE ALLOWED BEHIND, IN FRONT OR THROUGH CURRENT TRANSFORMER MOUNTING AREA BETWEEN LINE AND LOAD BUS BARS.
METAL CONDUIT FOR METER WIRES MAY ENTER AS SHOWN ON 5-3-19.1
6. METER EQUIPMENT ASSEMBLY (EXCLUDING METER ENCLOSURE) MAY BE INSTALLED A MINIMUM DISTANCE OF 6" ABOVE FLOOR INDOOR, 18" ABOVE GRADE OUTDOOR WITH A MAXIMUM DISTANCE OF 9" TO THE MIDDLE OF CT SECTION IN CABINET.
7. METER ENCLOSURE MAY BE INSTALLED A MINIMUM DISTANCE OF 42" FROM CENTER OF METER GLASS TO FLOOR OR GRADE WITH A MAXIMUM DISTANCE OF 6" TO THE TOP OF THE ENCLOSURE.
8. CONDUIT MAY ENTER THE SERVICE JUNCTION BOX FROM TOP, BOTTOM, SIDES OR BACK.
9. THE SERVICE JUNCTION BOX SHALL BE EQUIPPED WITH APPROVED SEALING DEVICES.
10. POWER LEG IDENTIFICATION PER 2023 N.E.C. 110.15, 230.56 AND 408.3(E) & (F).

THE DTE ELECTRIC COMPANY ASSUMES NO RESPONSIBILITY FOR INJURY OR DAMAGE ARISING FROM THE USE OF THIS SPECIFICATION DIAGRAM

TYPICAL CURRENT TRANSFORMER CABINET INSTALLATION

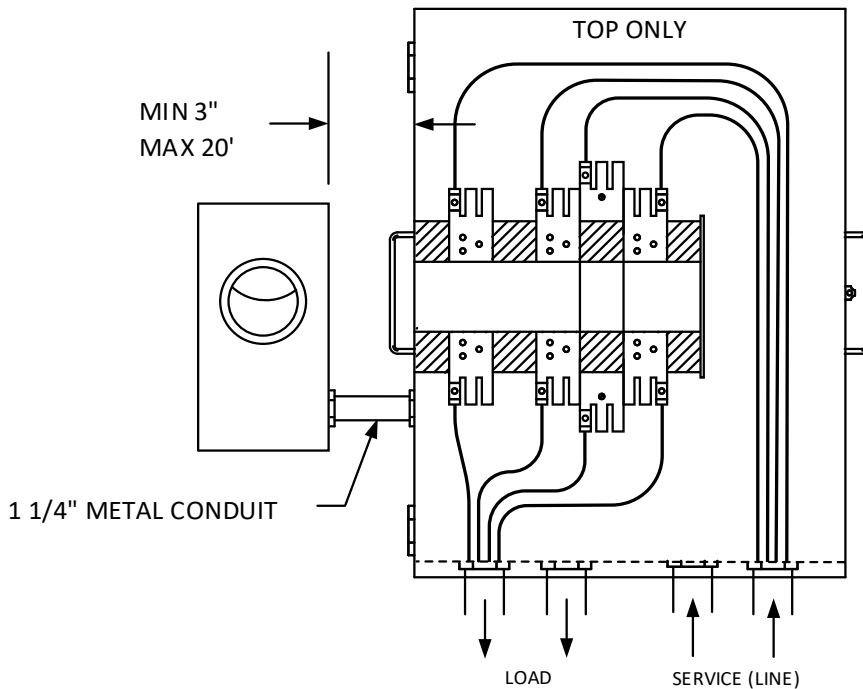
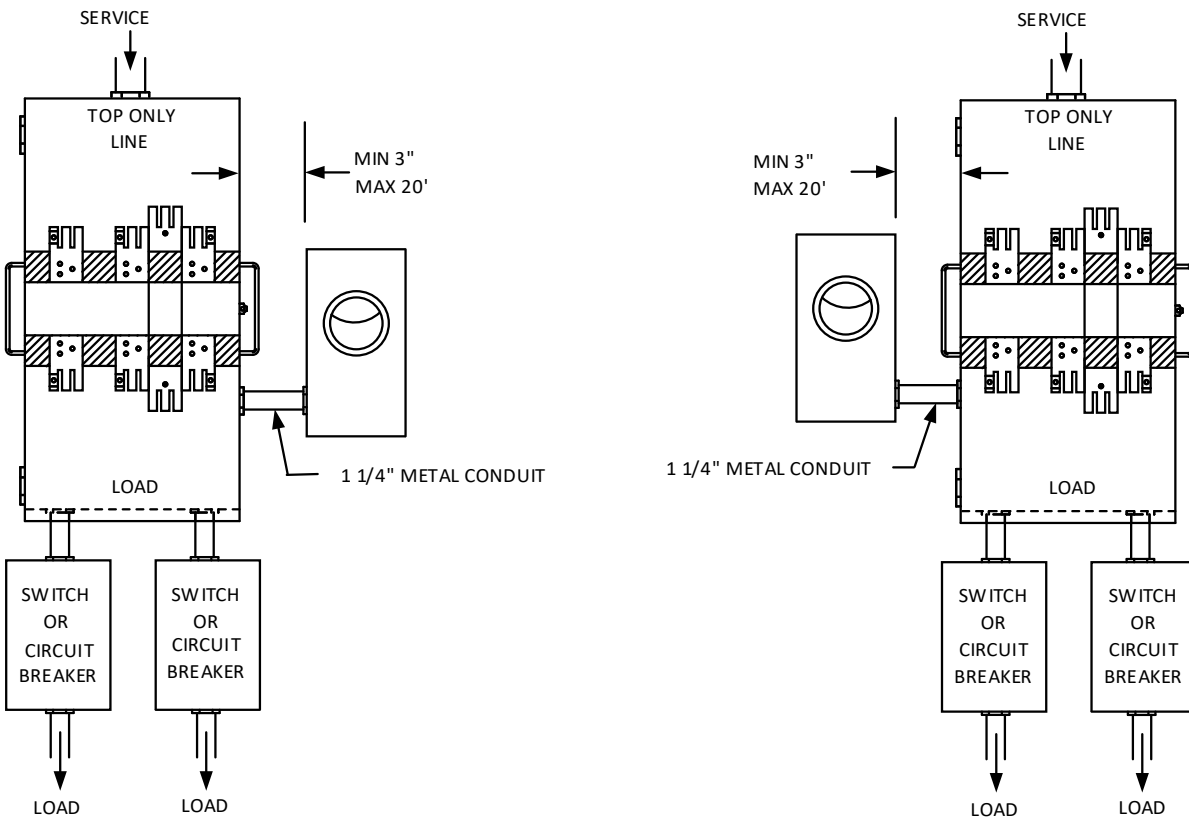

THE DTE ELECTRIC COMPANY ASSUMES NO RESPONSIBILITY FOR INJURY OR DAMAGE ARISING FROM THE USE OF THIS SPECIFICATION DIAGRAM.

Current Transformer Cabinet Inspection Routine

Page 1 of 4

Inspection Date Wanted _____

Address _____ Bldg _____ Fl _____ Apt/Rm _____ City/Town _____

Customer _____ Contractor _____

Planner _____ Telephone _____

Remarks _____

Inspector _____ Date Inspected _____

Remarks _____

- 0. DTE Electric approved CT cabinet / transocket Yes No
- 1. Address marked on stationary portion of meter enclosure Yes No
- 2. Meter enclosure and CT cabinet grouped Yes No
Residential -- both outside
Commercial / Industrial -- both inside or both outside
- 3. Safe and permanent access to metering equipment Yes No
- 4. **Working clearances** in front of meter enclosure and CT cabinet:
min. 30" wide by 36" deep (min. 30" wide by 48" deep for 480 V)..... Yes No
- 5. Workspace permits at least a 90° opening of CT cabinet door..... Yes No
- 6. Access clearances to meter enclosure and CT cabinet:
min. 24" wide by 6' 6" high and clear of obstructions Yes No
- 7. Customer's service disconnect(s) installed..... Yes No

Current Transformer Cabinet Inspection Routine

Page 2 of 4

- 8. Grounding electrode conductor installed and connected to Grounding Electrode System (NEC) Yes No
- 9. Check for correct voltages No check Yes No
- 10. CT cabinet mounted properly and fastened securely Yes No
- 11. CT cabinet min. 48" high by 24" wide by 10" deep Yes No
- 12. CT cabinet max. 9' from center of CT mounting section to floor or grade ... Yes No
- 13. CT cabinet inside min. 6" to floor..... N/A* Yes No
- 14. CT cabinet outside min. 18" to finished grade..... N/A* Yes No
- 15. CT bars installed properly with jumpering studs on *right-hand* side for CT Cabinet and *left-hand* side for Transocket..... Yes No
- 16. Check for proper spacing between bus bars with template..... Yes No
- 17. Area between line and load bus bars is free of conductors entering or passing through. (Free space must be clear for current transformers)..... Yes No
- 18. At least one conductor of each phase and one neutral in each CT cabinet line side conduit, when conduit fed (maximum of 8 conductors)..... Yes No
A separate grounding conductor (green wire) should not be installed in the service conduits.
- 19. Neutral bus tapped for 10-32 round head screw (provided) Yes No
- 20. Approved hasp or three-point latch provided for sealing (*no pop rivets*)..... Yes No
- 21. CT cabinet safely jumpered using jumpers that will not interfere with the installation of the current transformers N/A* Yes No
- 22. Line conductors identified Yes No

N/A* *Not Applicable*

Current Transformer Cabinet Inspection Routine

Page 3 of 4

- 23. Power leg at *center* bus position N/A* Yes No
- 24. Any backfeed on line or load conductors No check Yes No
- 25. Any faults in line or load conductors..... No check Yes No
- 26. Service entrance conduit type Metallic PVC (electrical) Pre-fab. Bus
- 27. Service conduit properly sized and supported N/A* Yes No
- 28. Weatherhead min. 6" *above* attachment point N/A* Yes No
- 29. Bus bar min. 18" *below* attachment point (30" preferred)..... N/A* Yes No
- 30. Service conductors extend min. 24" from weatherhead N/A* Yes No
- 31. Service entrance conductors or bus bars identified..... Yes No
- 32. Point of attachment to finished grade minimums met N/A* Yes No
Residential -- drip loop-10', driveway-12', street-18', hwy-22'
Commercial -- drip loop-12', bus-15', vehicular traffic-18', hwy-22'
- 33. Correct meter enclosure/socket installed:
 (form 9S or form 5S)..... Yes No
- 34. Inspect meter enclosure for sealing hasp, openings sealed, block cond., etc. Yes No
- 35. Meter enclosure securely fastened with sides and face vertically plumb Yes No
- 36. Meter enclosure height max. 6' to top, min. 3' 6" to center of meter face Yes No
- 37. Meter enclosure and CT cab. min. 1' horiz. clearance from inside corner Yes No
- 38. The edge of any metal or PVC terminal adapter, connector, or nipple
 entering meter box or CT cabinet is covered with a nonmetallic bushing..... Yes No

N/A* *Not Applicable*

Current Transformer Cabinet Inspection Routine

Page 4 of 4

- 39. Meter conduit enters meter enclosure at approved location Yes No
- 40. Meter conduit from CT cabinet min. 1-1/4 inch metal N/A* Yes No
(EMT, IMC or RMC) **PVC conduit is not acceptable**
- 41. Meter conduit length min. 3 inches, max. 20 feet..... N/A* Yes No
- 42. Meter enclosure on CT cabinet door:
(min.1-1/4 inch chase nipple and door made nonremovable)..... N/A* Yes No
- 43. **NO L.B.** use allowed with LINE side (unmetered) conductors. ALL conductors access
MUST BE SEALABLE by DTE Electric up to the metering equipment. All fittings must
conform with 2023 NEC 344.42 and 314.15.
- 44. The **Transocket** Neutral bar is grounded. N/A* Yes No

N/A* *Not Applicable*

Note: Not all of the above apply for Transockets.

TRANSOCKET INSTALLATIONS

1. DTE Electric defines *Transocket* as a single enclosure that contains a meter and current transformers and has the purpose of measuring electric energy flow. It includes a meter socket for a form 9S meter, a test switch, and current transformers mounting bars.

Currently approved Transockets are limited to 3 phase 4 wire service 400A max.

2. Transockets must be preapproved by DTE Electric - Meter Engineering in order to be accepted for use in our service territory. Only preapproved transockets will be energized. The DTE Electric approved transockets are listed on 5-4-2.
3. The meter and current transformers Ordering Routine is listed on 5-4-3.
4. The transocket accommodates the installation of approved Bar Type Current Transformers.
5. The transocket installation requirements must meet or exceed the current transformer installation standards (5-4-7, 5-4-10, 5-4-12) and the meter enclosure installation instructions (5-3-2 paragraphs 13, 14, 15, and 17).
6. Transockets can be fed from a Tap box with Service Planning approval.

TYPICAL TRANSOCKET INSTALLATION

METER SOCKET VIEW

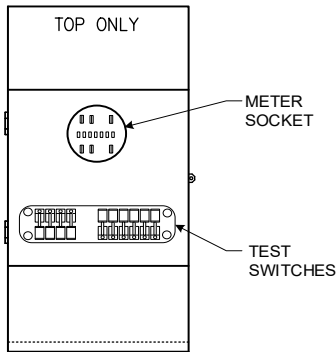

OVERHEAD

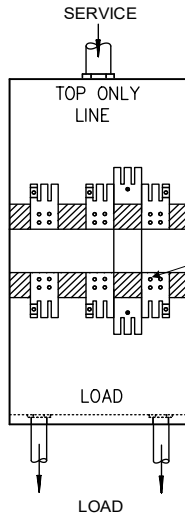

UNDERGROUND

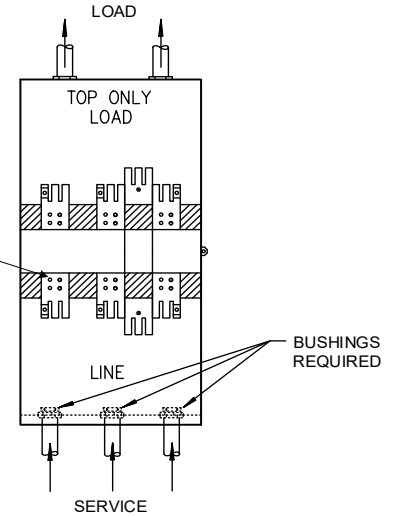

NOTE:
Install
Conductors &
Jumpers on the
left side studs
and reserve the
right side studs
for CTs install.

ANY BOND BETWEEN THE METER ENCLOSURE AND JOINT USERS THAT INTERFERES WITH REMOVING THE COVER ON THE METER BOX IS A VIOLATION OF NEC 250.94 (A)(3). THE JOINT USER WHO CREATED THE VIOLATION MUST CORRECT THE SITUATION.

CLEARANCE REQUIREMENTS FOR TRANSOCKET INSTALLATIONS

THESE DIMENSIONS ARE FOR INDOOR OR OUTDOOR INSTALLATIONS

DTE ELECTRIC REQUIREMENT FOR SIDE CLEARANCE
1" MINIMUM TO INSIDE CORNER,
METER BOX OR CURRENT TRANSFORMER CABINET

MINIMUM CLEARANCE DEPTH IN FRONT OF EQUIPMENT		
CONDITIONS	0-150V	151-600V
1* INSULATED WALL IN FRONT OF EQUIPMENT	3'	3'
2* WALL IN FRONT OF EQUIPMENT GROUNDED TO EARTH	3'	3 1/2'
3* DTE METERING EQUIPMENT ACROSS FROM OTHER EQUIPMENT WITH EXPOSED LIVE PARTS	3'	4'
4 LADDER REQUIRED TO REACH CURRENT TRANSFORMER COMPARTMENT FOR INSTALLATION	5'	5'

*CONDITIONS 1, 2 & 3 ARE MINIMUM WORKING SPACE PER NFPA 70 2023 NEC TABLE 110.26(A)(1) WORKING SPACES

FOR MINIMUM DEPTH IN FRONT OF EQUIPMENT SEE CHART AT RIGHT

30" MINIMUM CLEARANCE WIDTH FOR WORKING SPACE IN FRONT OF METER AND CURRENT TRANSFORMER CABINET PER 2023 N.E.C. 110.26(2)

DTE ELECTRIC COMPANY ASSUMES NO RESPONSIBILITY FOR INJURY OR DAMAGE ARISING FROM THE USE OF THIS SPECIFICATION DIAGRAM

FOR MAINTENANCE PURPOSES ONLY
BLADE MOUNT METERING CURRENT TRANSFORMERS
FOR INSTALLATION IN 3Ø PADMOUNT TRANSFORMERS

1. Description.

Blade mount current transformers (CTs) are similar to bar CTs except they do not have a primary current bar. Instead, they have a window opening which allows them to fit over the secondary spade terminals in padmount transformers. In effect, the secondary spade terminal becomes the CT primary bar. A grabber provides a firm grip on the terminal. Meter Engineering has tested and accepted these CTs as meeting Detroit Edison performance and physical requirements.

2. Application Restrictions.

Use of these CTs is permitted for customers who meet *all* of the following requirements:

- (a) Single customer, single rate account. (*Multiple rate accounts are excluded.*)
- (b) Customer is served from a *single* three-phase padmount transformer.
- (c) Customer is the *only* one served from that padmount transformer.

Note: The customer's electrical contractor must confirm acceptance of this metering method with the Detroit Edison Planner *before* beginning construction.

3. Maintenance Routine.

Detroit Edison will no longer allow the mounting of meter enclosures on the padmount transformer.

When an existing padmount transformer needs to be replaced, the customer responsibility is to supply and install a post mounted ZS3-20 meter enclosure and associated conduit.

See page 5-5-3 for details.

4. Table of Window Type Current Transformers.

<u>MMS Stock No.</u>	<u>Metering Ratio</u>	<u>Current Ratio</u>	<u>Nameplate Rating</u>
641-3007	80:1	400:5	400 amps
641-3012	160:1	800:5	800 amps
641-3015	300:1	1500:5	1500 amps
641-3018	600:1	3000:5	3000 amps

Planners will always size current transformers for the expected maximum *demand* load in amperes (not the *connected* load). Do not exceed nameplate rating.

**SPECIFICATIONS FOR CURRENT TRANSFORMER
SECTION OF CUSTOMER OWNED SWITCHBOARDS**

1. The building owner is responsible for the selection, purchase, installation, and maintenance of the switchboard.
2. The switchboard must provide a current transformer section which follows the specifications in subsection 5-6. The switchboard may also provide facilities for installation of the watt-hour meter and its enclosure in compliance with the specifications on page 5-6-03.
3. The current transformer section of the switchboard together with all unmetered buswork shall be located behind a sealable access.
4. Suitably plated electrical grade copper aluminum bus is acceptable as current carrying conductors.
5. When using copper, a single bus bar may be used up to 1200A, two bus bars must be used for installations above 1200A. When using aluminum, a single bus bar may be used up to 850A, two or more bus bars must be used above 850A.
6. All bus bars must be minimum ¼” thick. The service capacity determines the number of bars required per phase and their width (in accordance with the specifications on page 5-6-05). In the current transformer section of the switchboard multiple bars must be separated by a ¼” spacer hold. Units containing bus bar for current transformer installation must be shipped with details that ensure vertical and horizontal alignment during shipping and the installation process. These shipping details shall be removed prior to current transformer installation.
7. Single bus bar configurations may be mounted either edge to front or flat to front. Multiple bus bar configurations must be mounted edge to front.
8. The neutral bus meter connection must be extended forward with a 10-32 screw perpendicular to the front face of the cabinet. See page 5-6-02.
9. “N” neutral bus may be at either side of bus ducts provided bus spacings are maintained. Delta installations require “P” power bus in center position with the two “L” lighting buses on each side of the power bus.
10. Dimensions and drilling details for the buswork in the current transformer section of the switchboard are on page 5-6-06 & 5-6-07 as applicable. These are given per ANSI C12.11-2006 (R2019).
11. Template (see 5-6-08) shall be used by the Service Planner to gauge the current transformer mounting space before requesting current transformer installation. All dimensions given for the current transformer section of the switchboard are held in accordance with current transformer specifications as per ANSI C12.11-2006 (R2019).

SPECIFICATIONS FOR CURRENT TRANSFORMER
SECTION OF CUSTOMER OWNED SWITCHBOARDS (cont.)

12. Dimension and drilling details for the bus at the service head are on page 5-6-5. No other bus service head configurations are allowed.
13. Information pertaining to the mounting of the meter enclosure, and the current transformer section door area is on page 5-6-3.
14. Switchboards must be labeled according to their feed and load configuration. Switchboards and or transformer compartments must be labeled as, "Bottom Connected" if there feed is bottom connected. The manufacture shall label these units. This is the ultimate responsibility of the contractor and or customer. Failure to do so may result in service installation delays.

**CURRENT TRANSFORMER SECTION
OF CUSTOMER OWNED SWITCHBOARD
400-1000 AMPS**

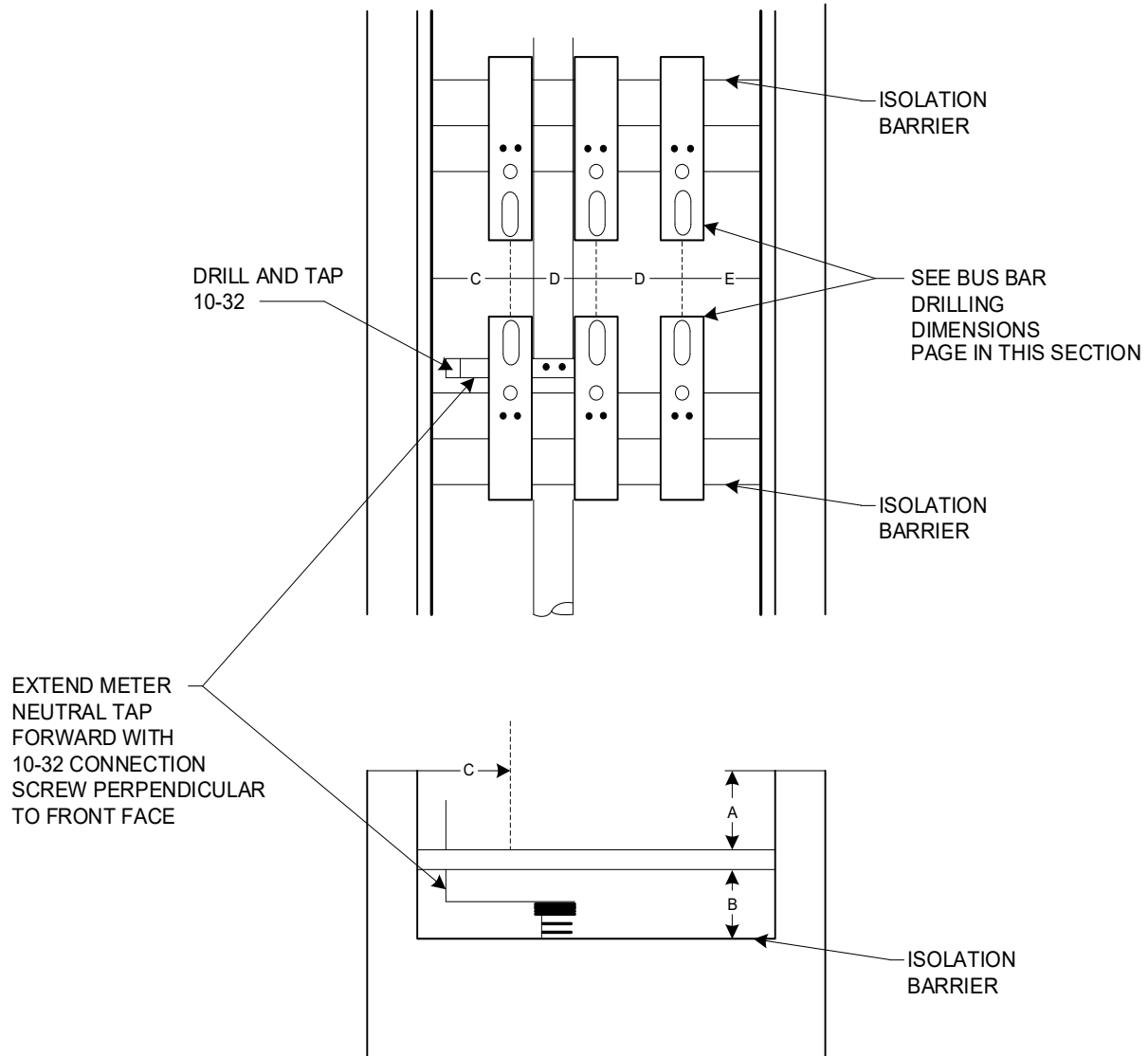

SWITCHBOARD AMPERE RATING	A	B	C	D	E
400 - 1000	5 - 1/2	4 - 1/2	3 - 1/2	7"	3 - 1/2

NOTES:

1. ON FLAT SIDE TO FRONT BAR PLACEMENT SHOWN, ALL BUS BARS MUST BE MINIMUM 1/4 THICK
2. MINIMUM DOOR OPENING IS 27 - 1/2 HIGH AND MUST BE CENTERED OVER CURRENT TRANSFORMERS. SPACING FROM BUS TO DOOR MUST BE CONSIDERED. THIS INCLUDES DOOR FLANGES, REINFORCEMENT SHAPES AND LATCHING MECHANISMS.

DTE ELECTRIC COMPANY ASSUMES NO RESPONSIBILITY FOR INJURY OR DAMAGE ARISING FROM THE USE OF THIS SPECIFICATION DIAGRAM.

CURRENT TRANSFORMER SECTION
OF CUSTOMER OWNED SWITCHBOARD
1200-3000 AMPS

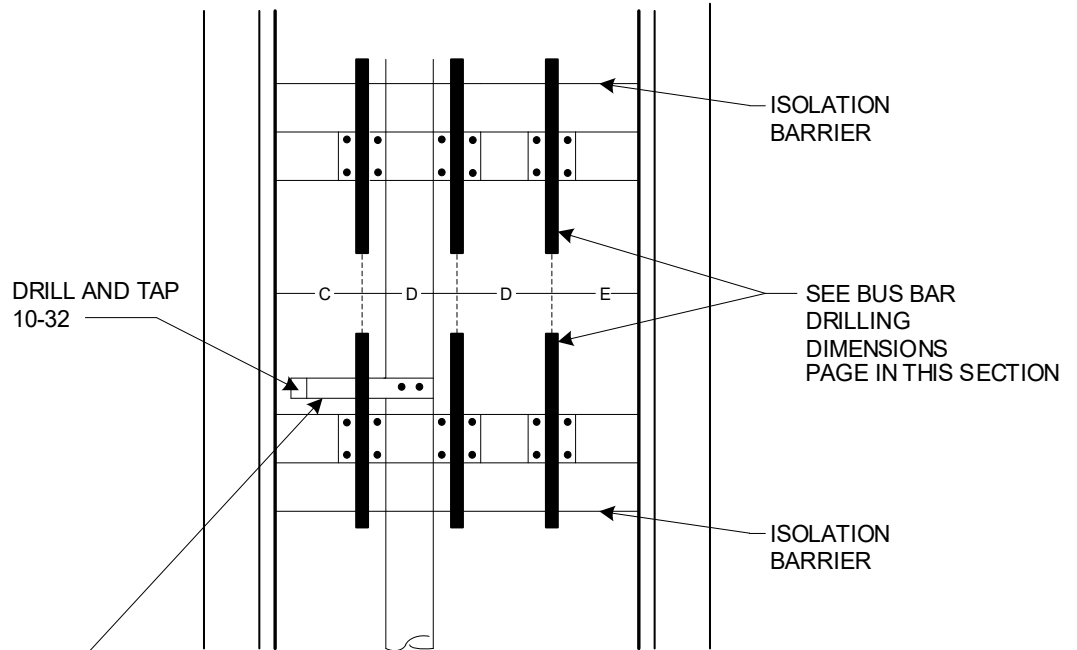

EXTEND METER NEUTRAL TAP FORWARD WITH 10-32 CONNECTION SCREW PERPENDICULAR TO FRONT FACE

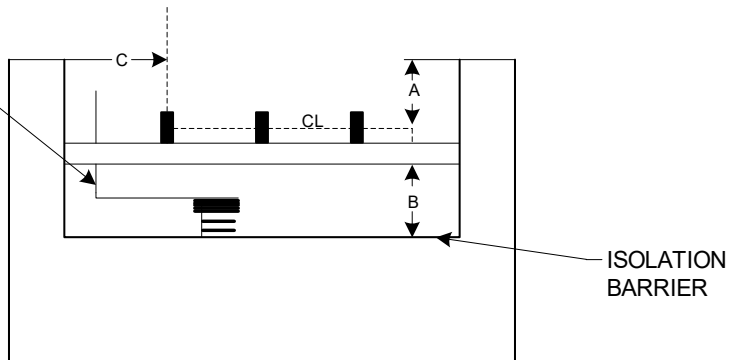

SWITCHBOARD AMPERE RATING	A	B	C	D	E
1200 - 3000				8"	

NOTES:

1. ALL BUS BARS MUST BE 1/4 THICK AND SPACING BETWEEN BARS MUST BE 1/4
2. MINIMUM DOOR OPENING IS 27 - 1/2 HIGH AND MUST BE CENTERED OVER CURRENT TRANSFORMERS. SPACING FROM BUS TO DOOR MUST BE CONSIDERED. THIS INCLUDES DOOR FLANGES, REINFORCEMENT SHAPES AND LATCHING MECHANISMS.

DTE ELECTRIC COMPANY ASSUMES NO RESPONSIBILITY FOR INJURY OR DAMAGE ARISING FROM THE USE OF THIS SPECIFICATION DIAGRAM.

METER ENCLOSURE MOUNTING FOR CURRENT TRANSFORMER COMPARTMENTS IN SWITCHBOARDS

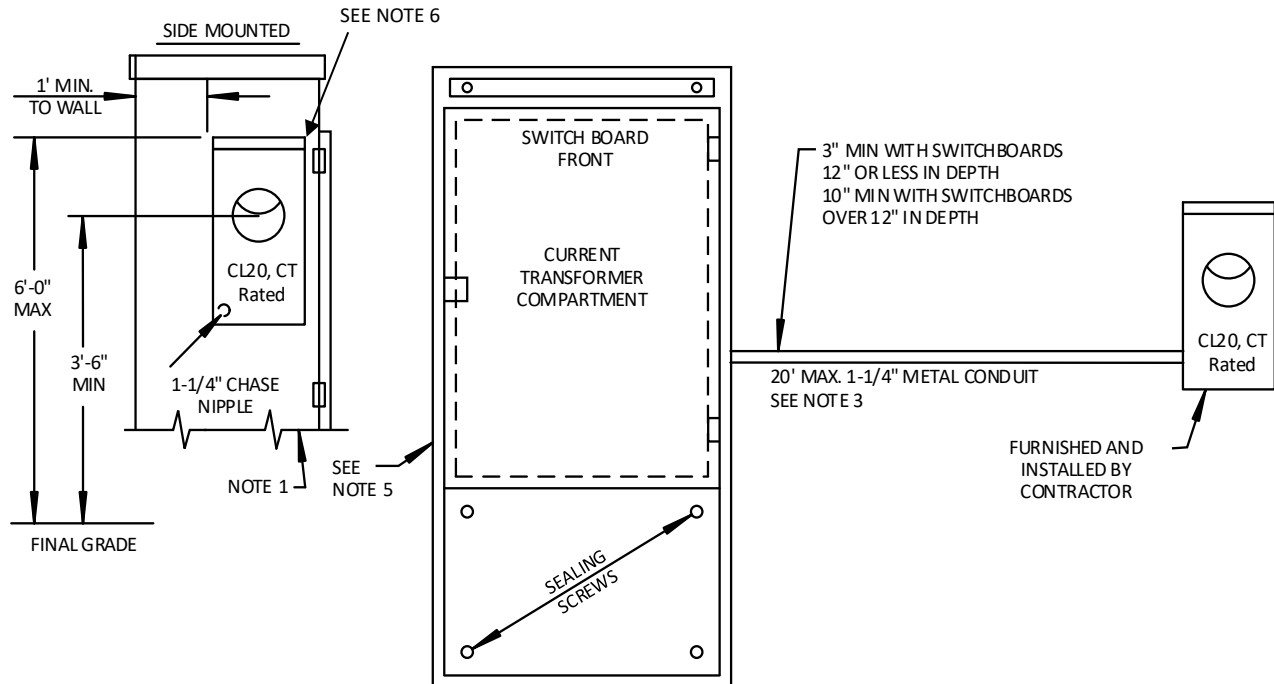

NOTES:

1. BARRIERS ARE REQUIRED TO SEPARATE THE METERING AREA FROM ANY OTHER AREAS IN THE SWITCHBOARD ASSEMBLY WHICH CONTAIN EQUIPMENT OR CONDUCTORS CARRYING METERED CURRENT.
2. THE CL20, CT RATED METER ENCLOSURE MUST BE MOUNTED WITHIN VIEWING RANGE OF THE CURRENT TRANSFORMER COMPARTMENT. IT MAY BE MOUNTED ON THE DOOR OF THE CURRENT TRANSFORMER COMPARTMENT, ONLY WHEN NO OTHER SPACE IS AVAILABLE. 1-1/4" METAL CONDUIT OR CHASE NIPPLE ENTRY MUST NOT INTERFERE WITH BYPASS HANDLE OR TEST SWITCHES.
3. THE MAXIMUM LENGTH OF 1-1/4" METAL CONDUIT THAT CAN BE RUN FROM THE CT RATED METER ENCLOSURE TO THE CURRENT TRANSFORMER SECTION OF SWITCHBOARD IS 20 FEET.
4. THE CL20, CT RATED METER ENCLOSURE MUST BE MOUNTED AT A MINIMUM DISTANCE OF 3'6" FROM THE CENTER OF METER TO FINAL GRADE AND A MAXIMUM DISTANCE OF 6' FROM TOP OF METER ENCLOSURE TO FINAL GRADE.
5. THE DOOR OF THE CURRENT TRANSFORMER COMPARTMENT MUST BE EQUIPPED WITH A DTE APPROVED SEALABLE LATCH. SEE PAGES 5-6-09 AND 10.
6. ANY BOND BETWEEN THE METER ENCLOSURE AND JOINT USERS THAT INTERFERES WITH REMOVING THE COVER ON THE METER BOX IS A VIOLATION OF NEC 250.94 (A)(3). THE JOINT USER WHO CREATED THE VIOLATION MUST CORRECT THE SITUATION.

THE DTE ELECTRIC COMPANY ASSUMES NO RESPONSIBILITY FOR INJURY OR DAMAGE ARISING FROM THE USE OF THIS SPECIFICATION DIAGRAM.

METER WIRING RACEWAY INSTALLATIONS THROUGH SWITCHBOARD COMPARTMENTS

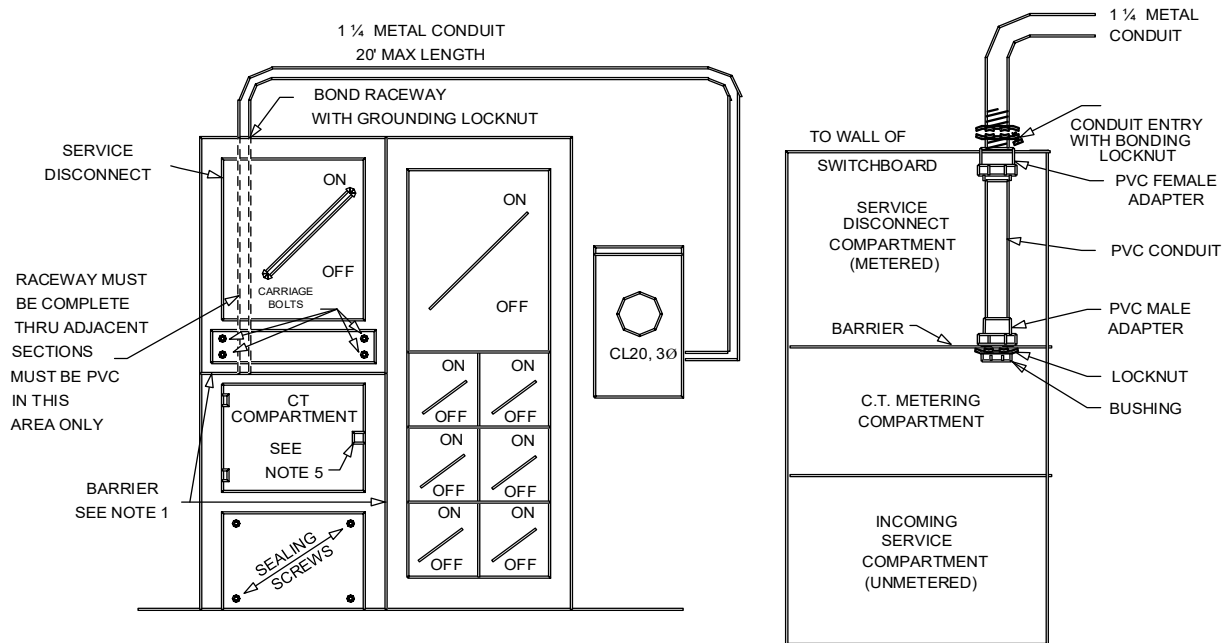

NOTES:

1. BARRIERS ARE REQUIRED TO SEPARATE THE METERING AREA FROM ANY OTHER AREAS IN THE SWITCHBOARD ASSEMBLY WHICH CONTAIN EQUIPMENT OR CONDUCTORS CARRYING METERED CURRENT.
2. THE METER ENCLOSURE MUST BE MOUNTED WITHIN VIEWING RANGE OF THE CURRENT TRANSFORMER COMPARTMENT. IT MAY BE MOUNTED ON THE DOOR OF THE CURRENT TRANSFORMER COMPARTMENT **ONLY** WHEN NO OTHER SPACE IS AVAILABLE.
3. THE MAXIMUM LENGTH OF 1 ½ METAL CONDUIT THAT CAN BE RUN FROM THE METER ENCLOSURE TO THE CURRENT TRANSFORMER SECTION OF SWITCHBOARD IS 20 FEET.
4. THE METER ENCLOSURE MUST BE MOUNTED AT A MINIMUM DISTANCE OF 3'6" FROM THE CENTER OF METER TO FINAL GRADE AND A MAXIMUM DISTANCE OF 6' FROM TOP OF METER ENCLOSURE TO FINAL GRADE.
5. THE DOOR OF THE CURRENT TRANSFORMER COMPARTMENT MUST BE EQUIPPED WITH A DTE APPROVED SEALABLE LATCH. SEE PAGES 5-6-09 AND 10

DTE ELECTRIC COMPANY ASSUMES NO RESPONSIBILITY FOR INJURY
OR DAMAGE ARISING FROM THE USE OF THIS SPECIFICATION DIAGRAM

DRILLING DETAILS FOR BUS AT SERVICE HEAD

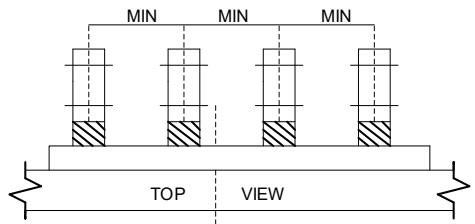
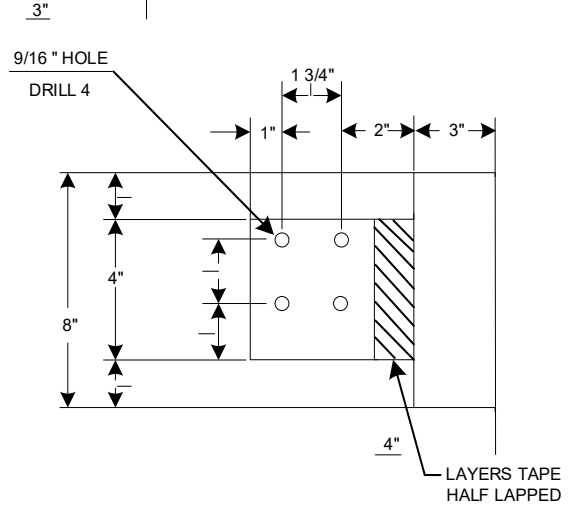
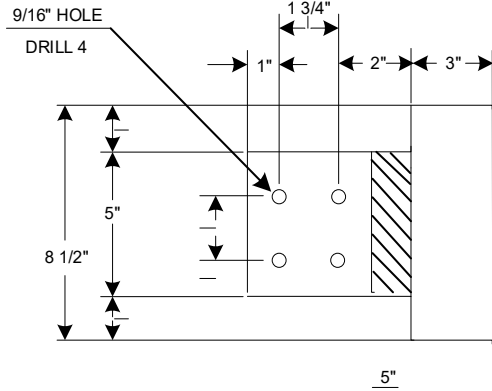
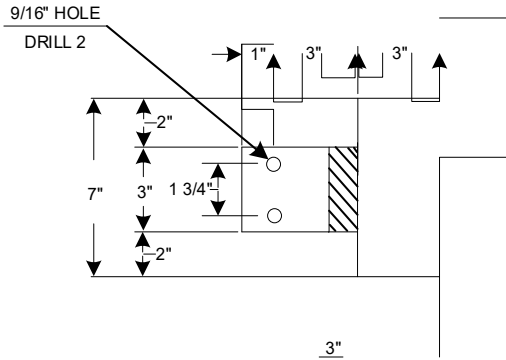

400-2000
AMPS CAPACITY

NO SPACE BETWEEN MULTIPLE
BUS BARS AT SERVICE HEADS

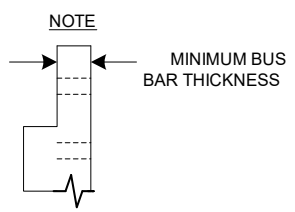
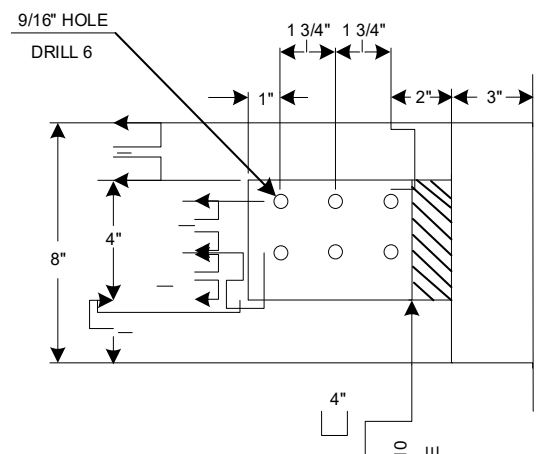
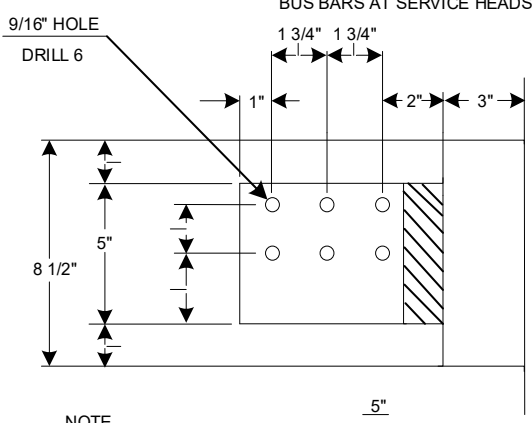

2001-3000
AMPS CAPACITY

15' MINIMUM 10
FINAL GRADE

2023 NEC
230.24(B)

DTE ELECTRIC COMPANY ASSUMES NO RESPONSIBILITY FOR INJURY OR DAMAGE ARISING FROM THE USE OF THIS SPECIFICATION DIAGRAM.

SINGLE BUS BAR DRILLING DETAILS AND DIMENSIONS FOR CUSTOMER OWNED SWITCHBOARD 400-100 AMPS

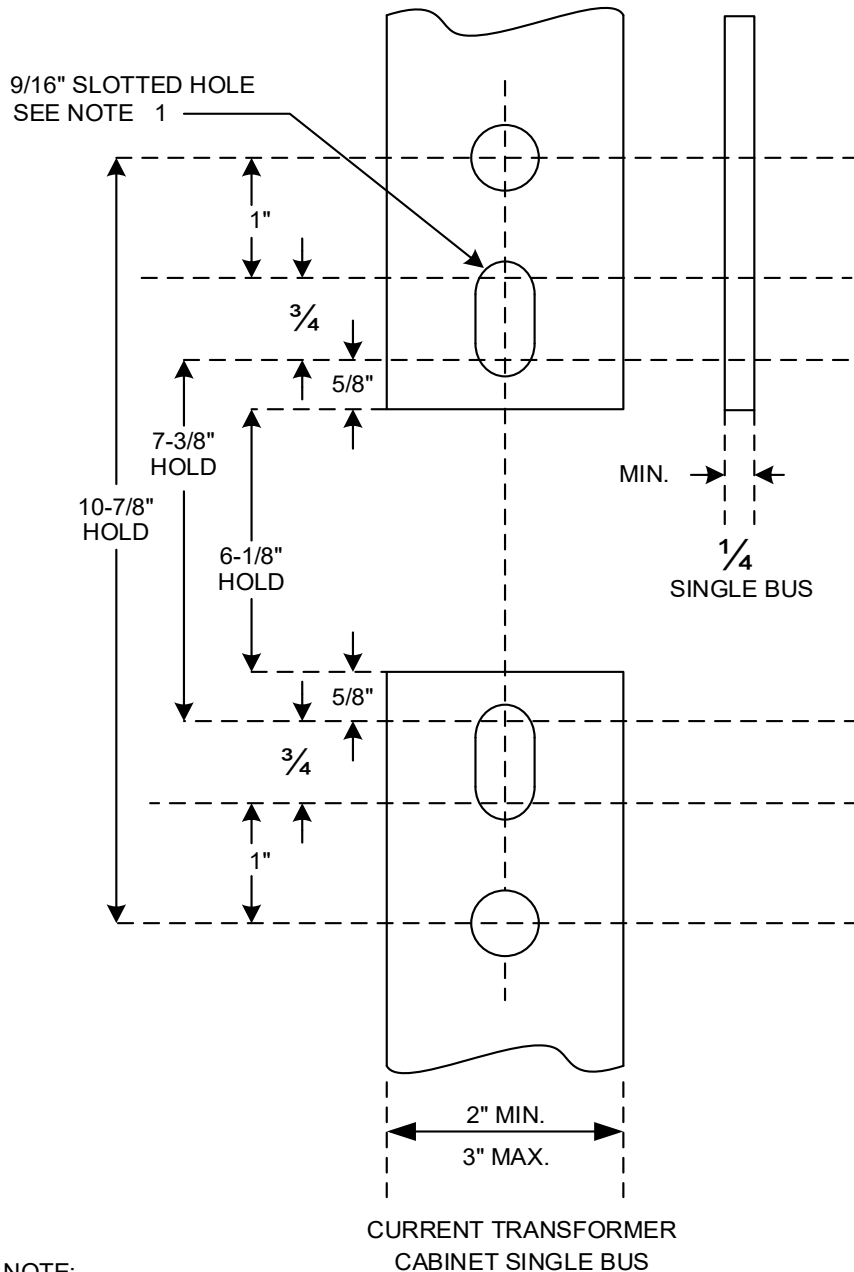

NOTE:

1. A SINGLE 9/16" HOLE MAY BE USED IN LIEU OF THE SLOTTED HOLE AS LONG AS THE HOLE IS PLACED WITHIN THE SPECIFIED LIMITS OF THE SLOTTED HOLE.

DTE ELECTRIC COMPANY ASSUMES NO RESPONSIBILITY FOR INJURY
OR DAMAGE ARISING FROM THE USE OF THIS SPECIFICATION DIAGRAM.

BUS BAR DRILLING DETAILS AND DEMENSIONS FOR CUSTOMER OWNED SWITCHBOARDS

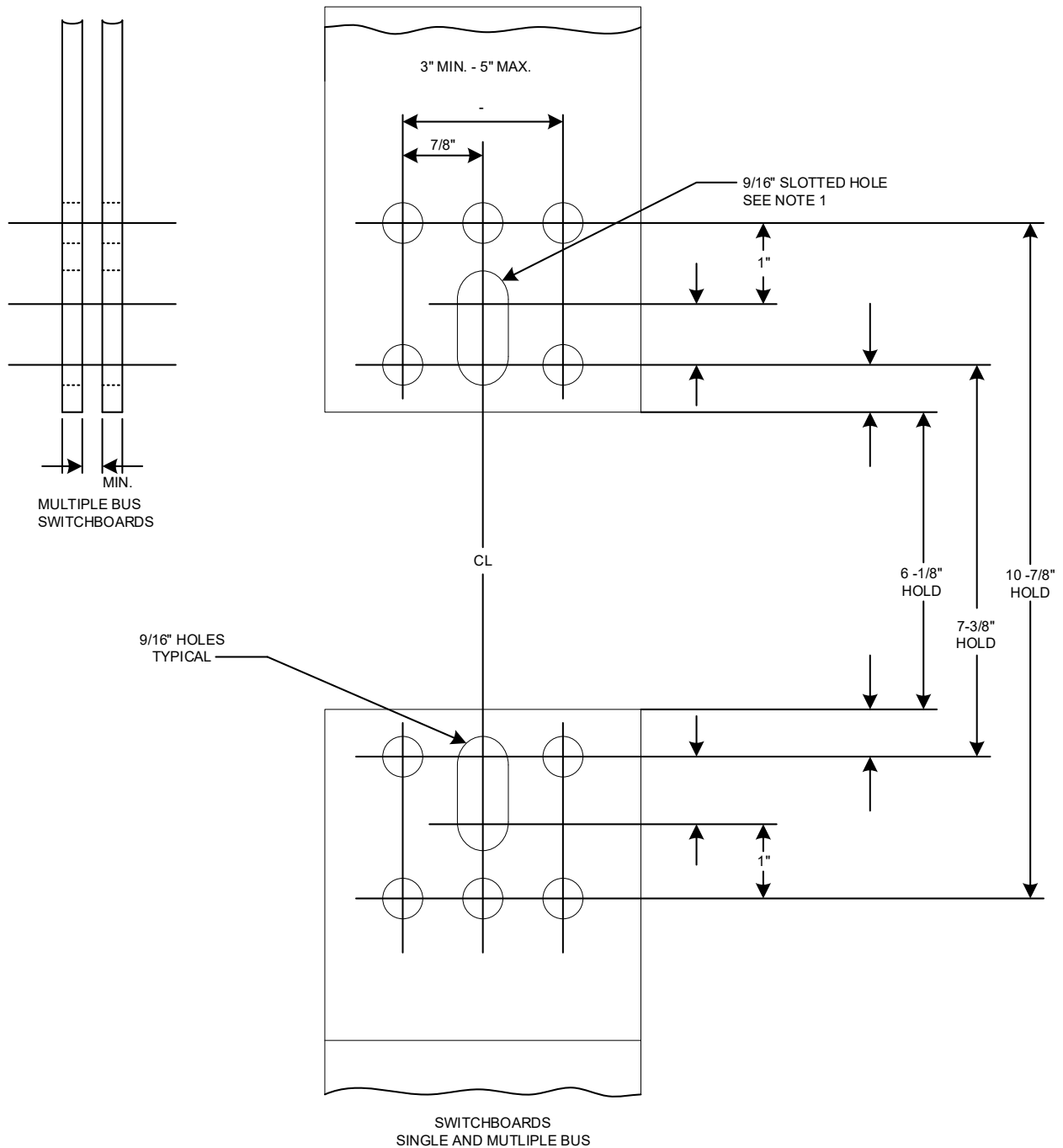

NOTE:

1. A SINGLE 9/16" HOLE MAY BE USED IN LIEU OF THE SLOTTED HOLE AS LONG AS THE HOLE IS PLACED WITHIN THE SPECIFIED LIMITS OF THE SLOTTED HOLE.

DTE ELECTRIC COMPANY ASSUMES NO RESPONSIBILITY FOR INJURY OR DAMAGE ARISING FROM THE USE OF THIS SPECIFICATION DIAGRAM.

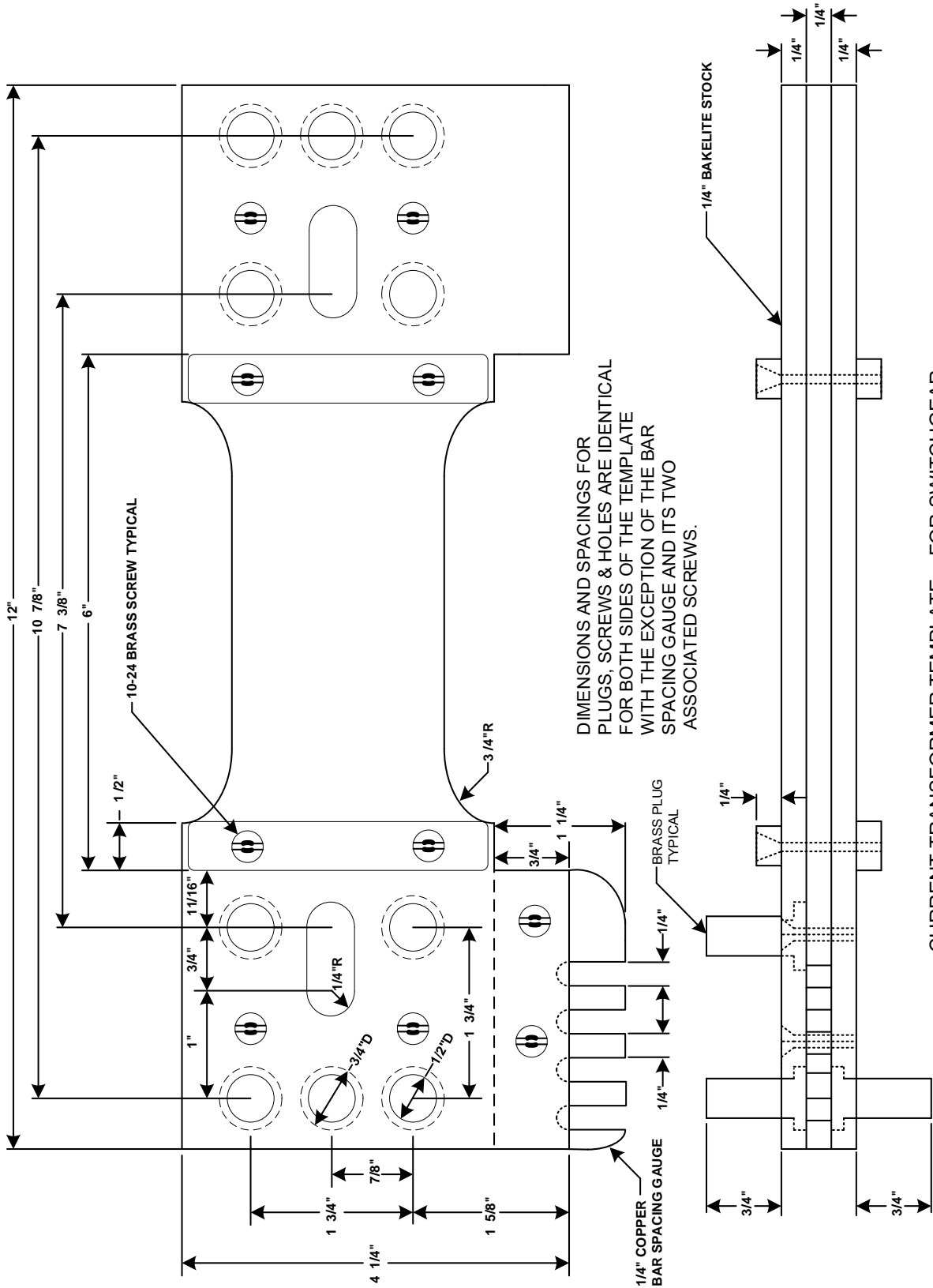

DIMENSIONS AND SPACINGS FOR PLUGS, SCREWS & HOLES ARE IDENTICAL FOR BOTH SIDES OF THE TEMPLATE WITH THE EXCEPTION OF THE BAR SPACING GAUGE AND ITS TWO ASSOCIATED SCREWS.

CURRENT TRANSFORMER TEMPLATE – FOR SWITCHGEAR

DTE ELECTRIC COMPANY ASSUMES NO RESPONSIBILITY FOR INJURY OR DAMAGE ARISING FROM THE USE OF THIS SPECIFICATION DIAGRAM.

APPROVED SEALING HASP
CT COMPARTMENT DOOR

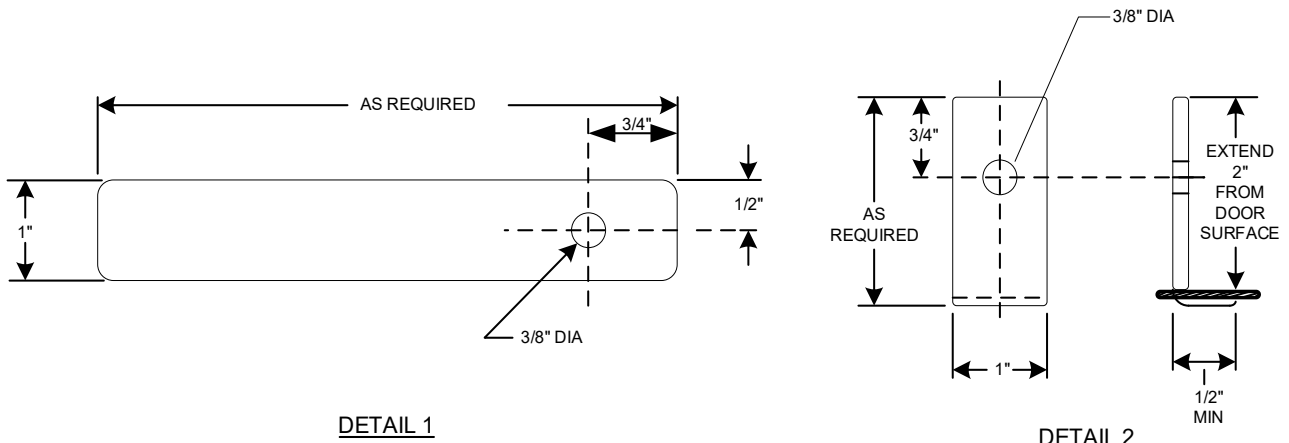

DETAIL 1

DETAIL 2

MATERIAL: 16 GAUGE NGG STEEL MINIMUM

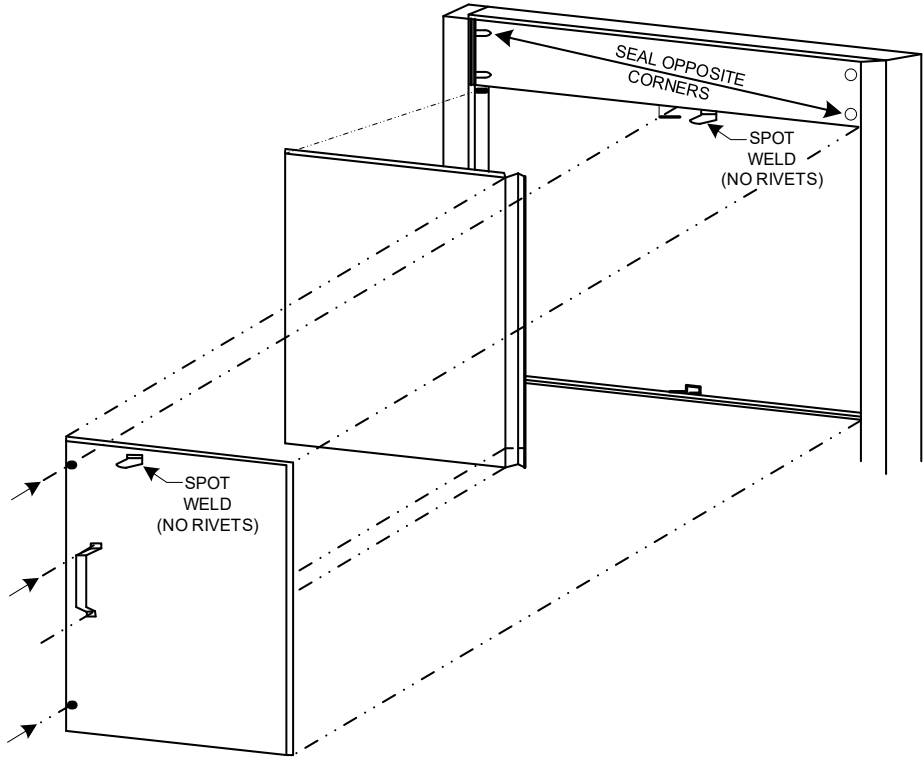

DOUBLE VERTICAL DOORS HINGED

- NOTES:
1. PANEL MUST BE SEALABLE AT OPPOSITE DIAGONAL CORNERS OR SECURED BY CARRIAGE BOLTS OR WELDED SEAMS. CARRIAGE BOLTS MUST BE USED WHEREVER POSSIBLE.
 2. SINGLE DOORS MUST USE A SEALING HASP AS SHOWN ABOVE. MAXIMUM DOOR WIDTH IS 36 INCHES.
 3. DOUBLE DOORS FOR CABINETS OVER 36 INCHES IN WIDTH MUST USE THE SEALING HASP AT THE TOP OF THE DOOR AS SHOWN IN THE DRAWING. THIS WILL PREVENT PARTIAL OPENING OF DOUBLE DOORS WITH SEALING INTACT

DTE ELECTRIC COMPANY ASSUMES NO RESPONSIBILITY FOR INJURY OR DAMAGE ARISING FROM THE USE OF THIS SPECIFICATION DIAGRAM.

APPROVED SEALING HASP CT COMPARTMENT DOOR

COVER SEALING OPTIONS

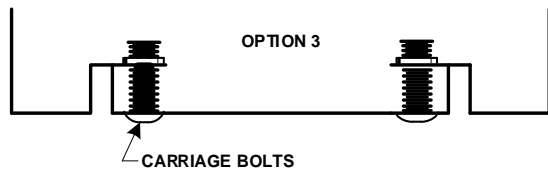
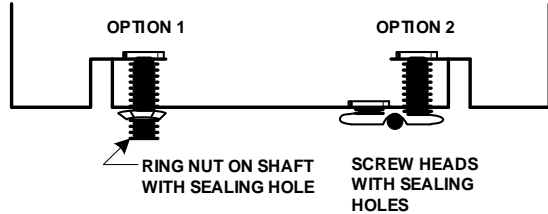

INSTALL CARRIAGE BOLTS OR SEALING SCREWS IN OPPOSITE CORNERS

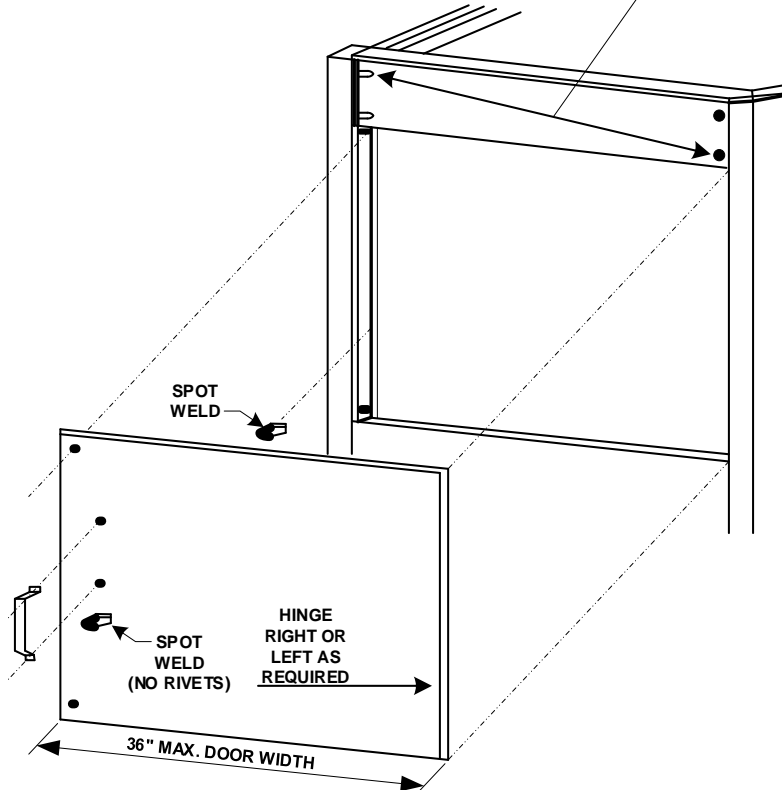

DOOR HASP SEALING REQUIREMENTS

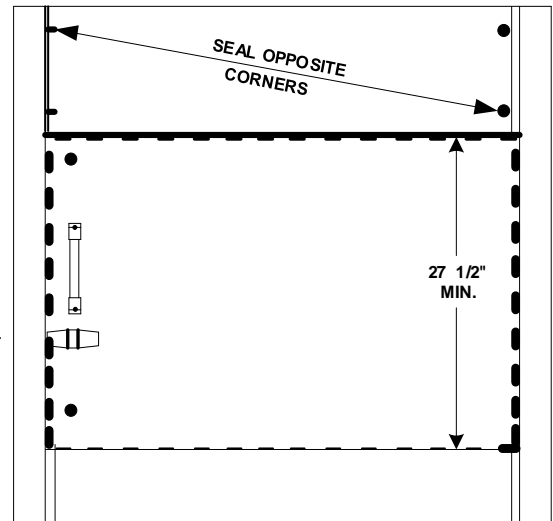
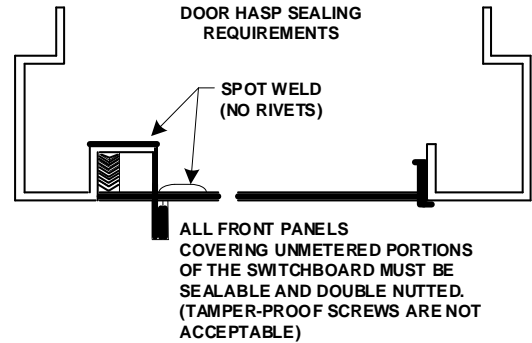

SINGLE VERTICAL DOOR HINGED

NOTES:

1. PANEL MUST BE SEALABLE AT OPPOSITE DIAGONAL CORNERS OR SECURED BY CARRIAGE BOLTS OR WELDED SEAMS. CARRIAGE BOLTS MUST BE USED WHEREVER POSSIBLE.
2. SINGLE DOORS MUST USE A SEALING HASP AS SHOWN ABOVE. MAXIMUM DOOR WIDTH IS 36 INCHES.
3. DOUBLE DOORS FOR CABINETS OVER 36 INCHES IN WIDTH MUST USE THE SEALING HASP AT THE TOP OF THE DOOR AS SHOWN IN THE DRAWING. THIS WILL PREVENT PARTIAL OPENING OF DOUBLE DOORS WITH SEALING INTACT

DTE ELECTRIC COMPANY ASSUMES NO RESPONSIBILITY FOR INJURY OR DAMAGE ARISING FROM THE USE OF THIS SPECIFICATION DIAGRAM.

SWITCHBOARDS**1. Services from 400 to 1000 Amperes.**

Cable services from 400 to 1000 amperes may be served at the customer's preference by a switchboard with a current transformer section. The customer may elect to use bus head entrance where overhead service is agreed upon. The meter will be installed by DTE Electric in an approved CT-rated enclosure, furnished and installed by the customer's contractor (see subsection 5-8). No other enclosure or meter block will be accepted. See pages 5-6-03 & 5-6-04 for acceptable configurations.

2. Services Exceeding 1000 Amperes.

Services greater than 1000 amperes require a switchboard with a current transformer section. These are usually custom-built for the installation. Consult with DTE Electric Service Planner for application restrictions.

3. Building Owner Responsibilities.

The building owner and those responsible for the service installation are also responsible for the selection and installation of switchboards. The building owner will furnish, own, and maintain such equipment except for the DTE Electric current transformers and the metering wires between the current transformers and the associated meter.

4. Conditions for Service.

DTE Electric reserves the right to refuse connection to service equipment that does not fulfill the following conditions:

- (a) Adequate service termination.
- (b) Separation of metered and unmetered conductors. In addition, PVC conduit containing metered wires is not allowed to pass through unmetered conductor compartment.
- (c) Sufficient access and working space for inspection, installation, maintenance, and testing of metering equipment. (See 2023 NEC 110.26, *Spaces About Electrical Equipment*.)
- (d) Assurance of proper operation of metering equipment.
- (e) Adequate clearances for installing current transformers commonly used by DTE Electric to meter the demand capability of the installed equipment.
- (f) Adequate provisions for DTE Electric sealing. (See pages 5-6-09 and 5-6-10.)

- (g) The contractor and customer are responsible for having the switchboard and current transformer section properly and permanently labeled as either top or bottom connected. This label should be easily viewed after the unit is installed.

5. Equipment Inspection.

Following is a list of manufactured switchboards that are available and acceptable to DTE Electric Company. In determining acceptability of these units, DTE does not make an overall evaluation of the unit or assume ultimate responsibility for its selection. This list is provided as a convenience for the customer to indicate units that have been inspected and used in the DTE Service Area. Other makes of equipment are not excluded; however, any equipment not listed must have its specifications submitted to the DTE Planner for review and acceptance *prior* to installation.

6. Specification Drawings.

The manufacturers listed below have submitted drawings of switchboard construction that have been accepted by DTE Electric. The contractor must submit approval drawings showing a one-line diagram and the equipment layout. The DTE drawing numbers must be referenced when showing current transformer compartment construction. New switchboard installations must always be inspected for compliance with minimum sealing and spacing requirements as shown in Section 5.

7. Acceptable Switchboards.

The following switchboards have been accepted for use in the DTE Electric Service Area. Manufacturers desiring to have their equipment listed may contact the DTE Electric Metering Department.

- | | |
|--------------------------------------|--|
| (a) <i>Challenger</i> | (g) <i>Square D</i> |
| (b) <i>Eaton (Cutler-Hammer)</i> | (h) <i>Salinger Electric Co.</i> |
| (c) <i>Electrical Power Products</i> | (i) <i>Continental Electrical Products</i> |
| (d) <i>General Electric</i> | (j) <i>ABB</i> |
| (e) <i>Park Metal Products</i> | |
| (f) <i>Siemens</i> | |

Switchboard Inspection Routine

Page 1 of 3

Inspection Date Wanted _____

Address _____ Bldg _____ Fl _____ Apt/Rm _____ City/Town _____

Customer _____ Contractor _____

Planner _____ Telephone _____

Remarks _____

Inspector _____ Date Inspected _____

Remarks _____

1. Address marked on stationary portion of meter enclosure Yes No
2. Meter enclosure within sight from CT compartment..... Yes No
3. Safe and permanent access to metering equipment Yes No
4. **Working clearances** in front of meter enclosure and CT compartment:
min. 30" wide by 36" deep (min. 30" wide by 48" deep for 480 V)..... Yes No
5. Workspace permits at least a 90° opening of CT compartment door(s)..... Yes No
6. Access clearances to meter enclosure and switchboard:
min. 24" wide by 6' 6" high and clear of obstructions Yes No
7. Grounding electrode conductor installed and connected to
Grounding Electrode System (NEC) Yes No
8. Barriers in CT compartment separating metering area from adjacent areas.. Yes No

Switchboard Inspection Routine

Page 2 of 3

- 9. 400-1000 amp swbd CT comp. min. 21" wide by 10" deep N/A* Yes No
- 10. 1200-3000 amp swbd CT comp. min. 28" wide by 12" deep N/A* Yes No
- 11. CT compartment door(s) min. 27-1/2" high, max. 36" wide Yes No
- 12. Verify bus bar dimensions and spacing with template: Yes No
(min. 1/4" thick; min. 3" wide, max. 5" wide)
- 13. Number of bus bars per phase..... No. _____
- 14. Area between line and load bus bars is free of conductors entering or passing through (free space must be clear for current transformers)..... Yes No
- 15. At least one conductor of each phase and one neutral in each Switchboard line side conduit, when conduit fed (maximum of 8 conductors)..... Yes No
A separate grounding conductor (green wire) should not be installed in the service conduits.
- 16. Neutral bus brought forward through barrier into CT compartment and tapped for 10-32 round head screw (provided)..... Yes No
- 17. Double hasp on CT compartment door(s) for sealing..... Yes No
- 18. Swbd panels sealable at opposite corners or secured with carriage bolts..... Yes No
- 19. Line conductors identified in CT compartment..... Yes No
- 20. Power leg at *center* bus position N/A* Yes No
- 21. Any backfeed on line or load conductors No check Yes No
- 22. Service entrance conduit type Metallic PVC (electrical) Pre-fab. Bus
- 23. Service conduit properly sized and supported N/A* Yes No
- 24. Weatherhead min. 6 inches *above* attachment point..... N/A* Yes No

N/A* *Not Applicable*

Switchboard Inspection Routine

Page 3 of 3

- 25. Bus bar min. 18 inches *below* attachment point (30" preferred) .. N/A* Yes No
- 26. Service conductors extend min. 24" from weatherhead N/A* Yes No
- 27. Service entrance conductors or bus bars identified..... Yes No
- 28. Point of attachment to finished grade minimums met N/A* Yes No
Residential -- drip loop-10', driveway-12', street-18', hwy-22'
Commercial -- drip loop-12', bus-15', vehicular traffic-18', hwy-22'
- 29. Correct meter enclosure installed (CT-rated) Yes No
- 30. Inspect meter enclosure for sealing hasp, openings sealed, block cond., etc. Yes No
- 31. Meter enclosure securely fastened with sides and face vertically plumb Yes No
- 32. Meter enclosure height max. 6' to top, min. 3' 6" to center of meter face Yes No
- 33. Meter enclosure min. 1-foot horizontal clearance from inside corner..... Yes No
- 34. The edge of any metal or PVC terminal adapter, connector, or nipple entering meter box or switchboard is covered with a nonmetallic bushing... Yes No
- 35. Meter conduit enters meter enclosure at approved location Yes No
- 36. Meter conduit from CT compartment min. 1-1/4 inch metal..... N/A* Yes No
 (EMT, IMC, or RMC). When passing through a switchboard section, PVC conduit must be used for that portion (See 5-6-04).
- 37. Meter conduit length: max. 20 feet N/A* Yes No
 min. 3 inches for switchboards 12 inches or less in depth
 min. 10 inches for switchboards over 12 inches in depth
- 38. Meter enclosure on CT compartment door: N/A* Yes No
 (min. 1-1/4 inch chase nipple and door made nonremovable)
- 39. **NO L.B.** use allowed with LINE side (unmetered) conductors. ALL conduits MUST BE INACCESSIBLE up to the metering equipment. All fittings must conform with 2023 NEC 344.42 and 314.15.

N/A* *Not Applicable*

**ROUTINES - LOAD PROFILE METERING INSTALLATIONS for
Large General Service Rate – 100KW Minimum Billing Demand Option,
Rider 1.1 – Metal Melting Rate, and Rider 1.2 – Process Heat Rate**

GENERAL

This section covers metering requirements for:

- Large General Service customers who request the 100KW Minimum Demand Billing Option.
- Secondary customers who request and qualify for Rider 1.1 or 1.2 – Metal Melting rate or Process Heat rate.

The metering requirements for these groups vary slightly. For the Large General Service customer, the existing meter will be replaced with a meter equipped with Load Profile recording capabilities. Secondary customers requesting Metal Melting or Process Heat metering require at least one additional meter with Load Profile recording capabilities to monitor the process circuit. Preferably, the additional meter(s) should be mounted within eight feet of the existing meter. If this cannot be accomplished, a second metering location is permissible and the installation must be installed according to the following referenced requirements:

DISCRIPTION	PAGE #	THROUGH	PAGE #
Meter Enclosure Installation	5-3-1	THROUGH	5-3-3
Outdoor Trough Installation	5-3-21		
CT Cabinets	5-4-1	THROUGH	5-4-8
Switch Boards	5-6-1	THROUGH	5-6-13

**Page numbers are referenced to this manual.
Some additional requirements are mentioned in this section.**

NOTE: The following paragraph contains the routine pertaining to these installations.

All requests for these services must be referred to a Major Account Representative, who is responsible for identifying the qualifying loads and securing the necessary service agreement. The Major Account Representative, along with the customer, will select a suitable area for the metering equipment and will advise of the customer’s responsibilities. Any service increase or relocation of equipment other than the meter enclosure, must involve the Service Planner who participates in the final selection of service equipment location. Service Planning will then coordinate any work required for the service increase or the service equipment relocation. The Major Account Representative will coordinate all metering equipment. Meter Engineering may assist the Major Account Representative where necessary.

A suitable outdoor location is preferred for the installation of the metering equipment. This metering location must be readily accessible. Access and working space must comply with 2023 NEC 110-26, *Spaces About Electrical Equipment*.

Installation Routine: (for all Current Transformer – Rated Secondary Installations).

- A. The customer shall:
1. Install socket based enclosures on all installations.
 2. Install meter enclosures at a suitable outdoor location.
 3. Existing inside meter enclosures installed on C.T. Cabinet doors or Switchboard Cabinets must be upgraded to meet all applicable requirements of item # 4 below.
 4. All meter locations must meet the following conditions:
 - I. If the existing meter on the process Heat or Metal Melting rate is an “A” or “B” base meter, the customer’s contractor shall install two “S” base meter enclosures outdoors.
 - II. Provide special circuits for metering the qualifying loads. These special circuits must include neutral and all voltage conductors. Additional meter enclosures should be mounted within 8 feet of existing meters.
 - III. If CT Cabinet is required, install the cabinet so that no more than 20 feet of 1- 1/4” conduit is required for CT secondary wires.
 - IV. Install 3/4” metal raceway conduit (liquid-tight or flexible) from the meter enclosure to the AC-10 box as shown on page 5-7-4.
 - V. Keep the area clear for easy, safe access for DTE personnel to read the meters, and test the meters. Working clearance guidelines 2023 NEC 110.26, *Spaces About Electrical Equipment*.
- B. Electrical Field Operations (EFO) service personnel will:
1. Replace the existing meter with a Load Profile meter. Install a Load Profile meter on the Process Heat and Metal Melting rate circuit.

Any questions regarding these routines can be directed to Meter Engineering at 313-389-7711.

BLANK

SECONDARY CUSTOMER PROCESS HEAT

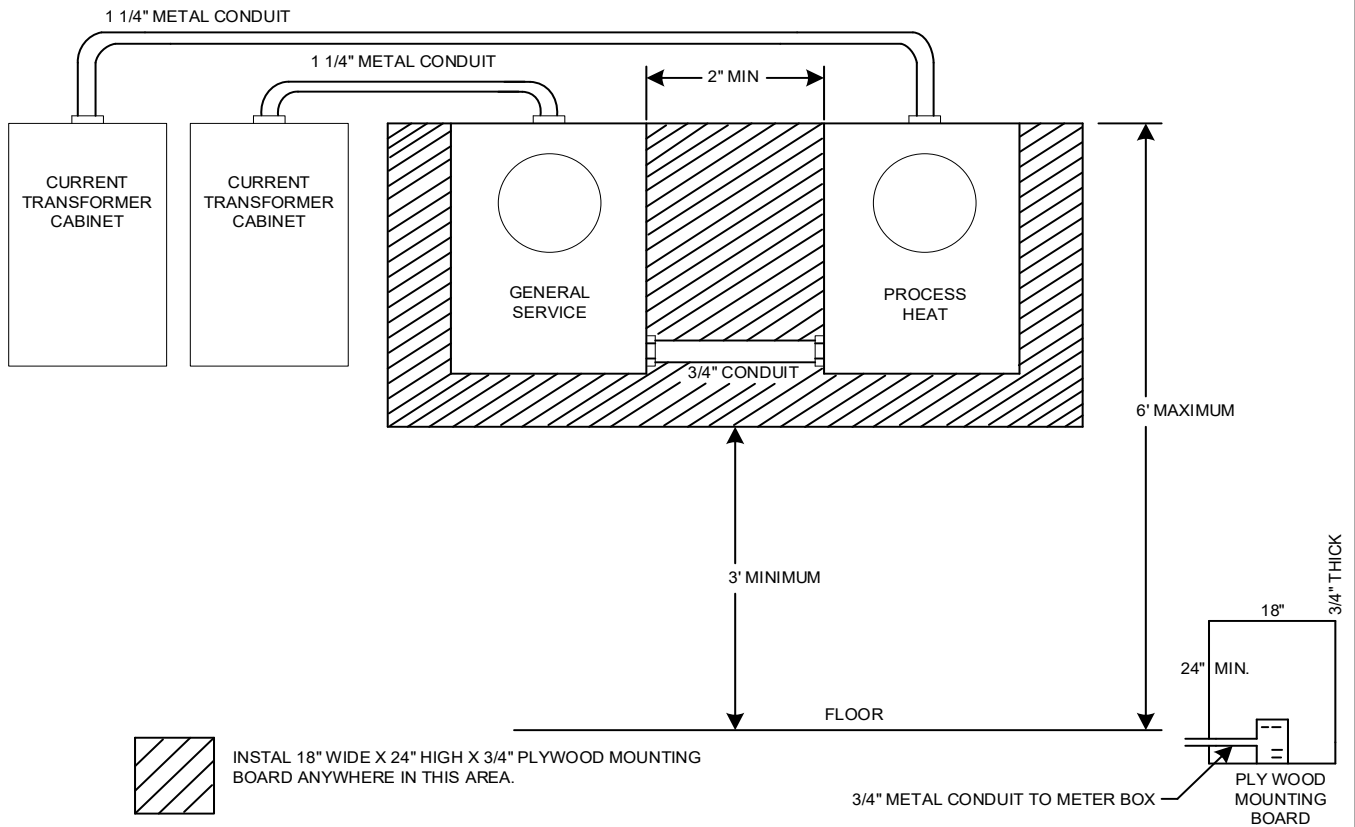

TYPICAL EQUIPMENT ASSEMBLIES

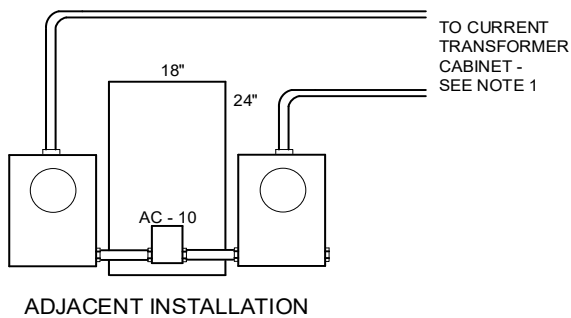
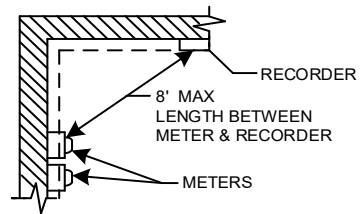
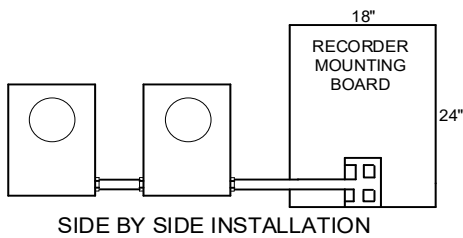

NOTES:

1. INSTALL THE CT CABINET SO THAT NO MORE THAN 20 FEET OF 1 1/4" METAL CONDUIT IS REQUIRED FOR CT SECONDARY WIRES FOR EACH METER.
2. KEEP AREA CLEAR FOR SAFE ACCESS FOR DTE PERSONNEL TO READ THE METERS, CHANGE THE TAPE, AND TEST THE METERS.

THE DTE ELECTRIC COMPANY ASSUMES NO RESPONSIBILITY FOR INJURY OR DAMAGE ARISING FROM THE USE OF THIS SPECIFICATION DIAGRAM.

LARGE GENERAL SERVICE RATE
100 KW MINIMUM BILLING DEMAND OPTION

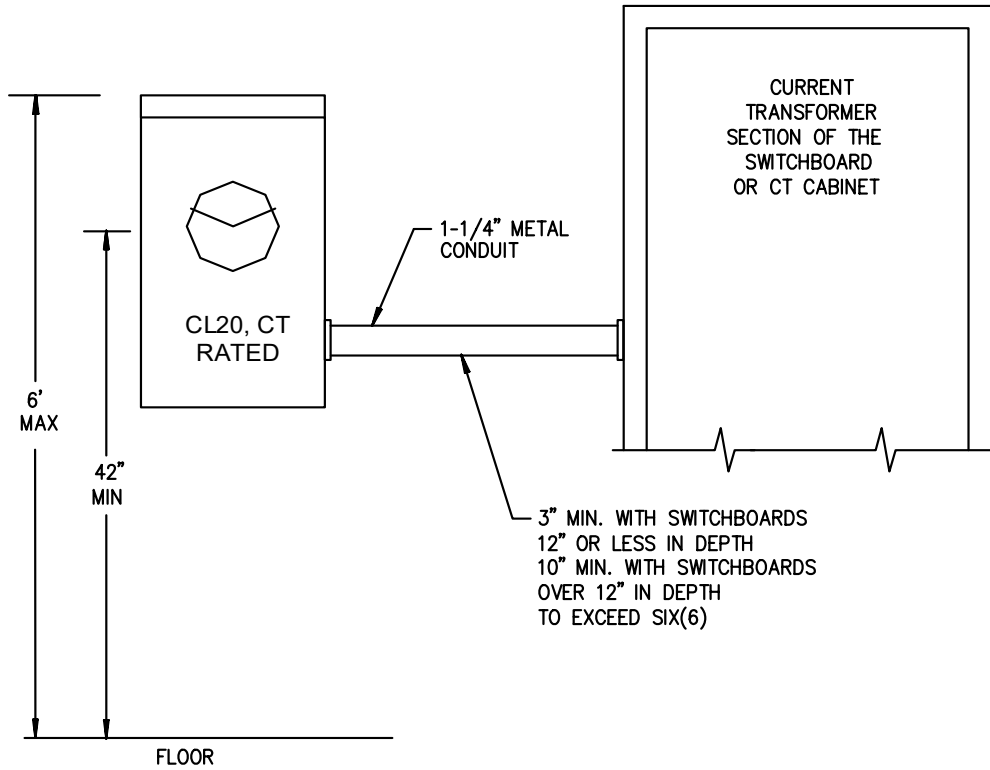

NOTES:

1. THE 1-1/4" METAL CONDUIT FOR METER WIRES MAY ENTER TOP, BOTTOM, OR SIDES OF METER ENCLOSURE.
2. DTE WILL INSTALL A SPECIAL METER WHICH WILL INCLUDE A BUILT IN LOAD PROFILE RECORDER.
3. CONTACT CUSTOMER SERVICE ENGINEERING AND ALLOW EIGHT WEEKS FOR METER.

THE DTE ELECTRIC COMPANY ASSUMES NO RESPONSIBILITY FOR INJURY
OR DAMAGE ARISING FROM THE USE OF THIS SPECIFICATION DIAGRAM

CUTLER-HAMMER – MULTIPLE METER EQUIPMENT
ACCEPTABLE FOR DTE METERING

DIMENSIONS ARE AVAILABLE FOR PLANNING THROUGH MANUFACTURER'S CATALOG

Main Circuit Breaker

AMPERES	SINGLE PHASE OUTDOOR ①②④	THREE PHASE OUTDOOR ①②④
400	1PMB400R	3PMB400R
600	1PMB600R	3PMB600R
800	1PMB800R	3PMB800R
1000	1PMB1000R	3PMB1000R
1200	1PMB1200R③	3PMB1200R③
1600	1PMB1600RBC③	3PMB1600RBC③

Main Terminal Box

AMPERES	SINGLE PHASE OUTDOOR ②④	THREE PHASE OUTDOOR ②④
400	3MTB400R	3MTB400R
600	3MTB600R	3MTB600R
800	1MTB800R	3MTB800R
1200	1MTB1200R③	3MTB1200R③
1600	1MTB1600RC③	3MTB1600RC③

Main Fusible Switch

AMPERES	FEED	SINGLE PHASE OUTDOOR ②④	THREE PHASE OUTDOOR ②④
400	Bottom	1MFS400RB	3MFS400RB
400	Top	1MFS400RT	3MFS400RT
600	Bottom	1MFS600RB	3MFS600RB
600	Top	1MFS600RT	3MFS600RT
800	Bottom	1MFS800RB	3MFS800RB
800	Top	1MFS800RT	3MFS800RT
1200	Bottom	1MFS1200RB③	3MFS1200RB③

Main Bolted Pressure Contact Switch

AMPERES	FEED	SINGLE PHASE OUTDOOR ②④	THREE PHASE OUTDOOR ②④
1600	Bottom	-	3BPS1600RB
1600	Top	-	3BPS1600RT

NOTES:

- ①Units are designed for bottom feed. If used for top feed, live bus must have a protective barrier from the LINE cable.
- ②Add “C” to end of catalog number for COPPER BUS.
- ③1200A or greater, main devices must be center fed when installing 800A residential meter stacks.
- ④NEMA type 3R construction.

JUL 2024

CUTLER-HAMMER – MULTIPLE METER EQUIPMENT
ACCEPTABLE FOR DTE METERING

DIMENSIONS ARE AVAILABLE FOR PLANNING THROUGH MANUFACTURER'S CATALOG

Single Phase Meter Stack Modules

SERVICE TYPE	METER SOCKET AMPERE RATING	VERTICAL METER POSITIONS	CATALOG NUMBERS	
			SINGLE PHASE IN	OUTDOOR THREE PHASE IN
1Ø 3W 120/240 Volt 4 JAW	125	2	use 3-Phase	3MM212R
		3	1MM312R	
		4	1MM412R	
		5	1MM512R	
		6	1MM612R	
3Ø 4W 120/208 Volt 5 JAW 3-PHASE IN 1-PHASE OUT	125	2		3MM212R
		3		3MM312R
		4		3MM412R
		5		3MM512R
		6		3MM612R
1Ø 3W 120/240 Volt 4 JAW	200	2	use 3-Phase	3MM220R
		3	1MM320R	
		4	1MM420R	
		5	1MM520R	
3Ø 4W 120/208 Volt 5 JAW 3-PHASE IN 1-PHASE OUT	200	2		3MM220R
		3		3MM320R
		4		3MM420R
		5		3MM520R

NOTES:

1. Fault Rating is determined by circuit breaker rating. Circuit breakers are ordered separately.
2. Consult manufacturer for information regarding fault current ratings.
3. Follow manufacturer's instruction for assembly.
4. Mounting height must conform to DTE Requirements. (See page 5-3-11)
5. Ring Style Meter Socket Covers. Order SCREW-TYPE sealing rings.
6. Add "C" to end of catalog number for COPPER BUS.
7. On a 120/208 Volt service, all modules are shipped with phase A-B connected. The stacks are readily connectable across phase A-C and phase B-C. The load must be balanced by the contractor.
8. NEMA type 3R construction

CUTLER-HAMMER – MULTIPLE METER EQUIPMENT
ACCEPTABLE FOR DTE METERING

DIMENSIONS ARE AVAILABLE FOR PLANNING THROUGH MANUFACTURER'S CATALOG

Single Phase Meter Packs

SERVICE TYPE	METER SOCKET AMPERE RATING	VERTICAL METER POSITIONS	CATALOG NUMBERS	
			OUTDOOR SINGLE PHASE	THREE PHASE
1Ø 3W 120/240 Volt 4 JAW	125	2	1MP2122R	
		3	1MP3124R	
		4	1MP4124R	
		5	1MP5126R	
		6	1MP6126R	
1Ø 3W 120/240 Volt 4 JAW	200	2	1MP2204R	
		3	1MP3206R	
		4	1MP4206R	
		5	1MP5206R	
		6	1MP6206R	
5 JAW			1MM5JK	

NOTES:

1. Fault Rating is determined by circuit breaker rating. Circuit breakers are ordered separately.
2. Consult manufacturer for information regarding fault current ratings.
3. Follow manufacturer's instruction for assembly.
4. Mounting height must conform to DTE Requirements. (See page 5-3-11)
5. Ring Style Meter Socket Covers. Order SCREW-TYPE sealing rings.
6. Add "C" to end of catalog number for COPPER BUS.
7. The fifth jaw must be ordered for all metering fed by 120/208 volt 3 phase.
8. NEMA type 3R construction.

JUL 2024

CUTLER-HAMMER – MULTIPLE METER EQUIPMENT
ACCEPTABLE FOR DTE METERING

DIMENSIONS ARE AVAILABLE FOR PLANNING THROUGH MANUFACTURER'S CATALOG

THREE PHASE METER STACK MODULES

SERVICE TYPE	METER SOCKET AMPERE RATING	VERTICAL METER POSITIONS	CATALOG NUMBERS
			THREE PHASE INDOOR/OUTDOOR
3Ø 4W	225	2	37MM220R12
120/208, 120/240** Volt	Note 1	3	37MM320R12
7 JAW		4	37MM420R12
3 POLE BRANCH (3 PHASE METERING)			
3-PHASE IN			
3-PHASE OUT			
		<ul style="list-style-type: none"> • NEMA type 3R construction • Ringless type with lever bypass and jaw release • 225 Amp maximum Branch Main 	

120/240V Service IN (B-Phase is High Leg) - **Meter Socket MUST have High (Power) Leg on Right

NOTES:

1. Fault Rating is determined by circuit breaker rating. Circuit breakers are ordered separately.
2. Consult manufacturer for information regarding fault current ratings.
3. Follow manufacturer's instruction for assembly.
4. Mounting height must conform to DTE Requirements. (See page 5-3-11)
5. Ringless Style Meter Socket Covers.

JUL 2024

SIEMENS – ITE MODULES
ACCEPTABLE FOR DTE METERING

DIMENSIONS ARE AVAILABLE FOR PLANNING THROUGH MANUFACTURER'S CATALOG

Circuit Breaker Module ②③

AMPERES	SINGLE PHASE OUTDOOR	THREE PHASE OUTDOOR
400	WB1400CU	WB3400CU
600	WB1600CU	WB3600CU
800	WB1800CU	WB3800CU
1000	WB11000CU	WB31000CU
1200	WB11200CU	WB31200CU
1600	WB11600CU	WB31600CU
2000	NA	WBM32000B

Tap Box Module③

AMPERES	SINGLE PHASE OUTDOOR	THREE PHASE OUTDOOR
400	WTB1400CU	WTB3400CU
800	WTB1800CU	WTB3800CU
1200	WTB11200CU	WTB31200CU
1600	WTB11600CU	WTB31600CU

Fusible Switch Module ①③

AMPERES	SINGLE PHASE OUTDOOR	THREE PHASE OUTDOOR
400	WS1400CU	WS3400CU
600	WS1600CU	WS3600CU
800	WS1800CU	WS3800CU
1200	WS11200BU	WS31200BU

NOTES:

1. An optional Surge Protection module is allowed. The catalog number is WSPDxxxxx.
2. An optional Arc Flash Reduction Maintenance System is allowed. The catalog number is WBMxxxxx.
3. NEMA type 3R construction.

JUL 2024

SIEMENS – ITE MODULES
ACCEPTABLE FOR DTE METERING

DIMENSIONS ARE AVAILABLE FOR PLANNING THROUGH MANUFACTURER'S CATALOG

SINGLE PHASE METER STACKS

SERVICE TYPE	METER SOCKET AMPERE RATING	VERTICAL METER POSITIONS	CATALOG NUMBERS OUTDOOR	
			SINGLE PHASE	THREE PHASE
1Ø 3W 120/240 Volt 4 JAW	125	2	WMM21125	
		3	WMM31125	
		4	WMM41125	
		5	WMM51125	
		6	WMM61125	
3Ø 4W 120/208 Volt 5 JAW 3-PHASE IN 1-PHASE OUT	125	2		WMM22125J
		3		WMM32125J
		4		WMM42125J
		5		WMM52125J
		6		WMM62125J
1Ø 3W 120/240 Volt 4 JAW	200	2	WMM21225	
		3	WMM31225	
		4	WMM41225	
		5	WMM51225	
		6	WMM61225	
3Ø 4W 120/208 Volt 5 JAW 3-PHASE IN 1-PHASE OUT	200	2		WMM22225J
		3		WMM32225J
		4		WMM42225J
		5		WMM52225J
		6		WMM62225J

NOTES:

1. Fault Rating is determined by circuit breaker rating. Circuit breakers are ordered separately.
2. Consult manufacturer for information regarding fault current ratings.
3. Follow manufacturer's instruction for assembly.
4. Mounting height must conform to DTE Requirements. (See page 5-3-11)
5. Ring Style Meter Socket Covers. Order SCREW-TYPE sealing rings.
6. NEMA type 3R construction

JUL 2024

SIEMENS – ITE MODULES
ACCEPTABLE FOR DTE METERING

DIMENSIONS ARE AVAILABLE FOR PLANNING THROUGH MANUFACTURER'S CATALOG

METER UNI-PAKS

SERVICE TYPE	METER SOCKET AMPERE RATING	VERTICAL METER POSITIONS	CATALOG NUMBERS OUTDOOR	
			SINGLE PHASE	THREE PHASE
1Ø 3W 120/240 Volt 4 JAW	125	2	WP2211	
		3	WP3311	
		4	WP4411	
		5	WP4511	
		6	WP4611	
		4	WP6411	
		5	WP6511	
		6	WP6611	
3Ø 4W 120/208 Volt 5 JAW 3-PHASE IN 1-PHASE OUT	125	2		WP2211J
		3		WP3311J
		4		WP4411J
		5		WP4511J
		6		WP4611J
		4		WP6411J
		5		WP6511J
		6	WP6611J	
1Ø 3W 120/240 Volt 4 JAW	200	2	WP4212	
		3	WP4312	
		4	WP4412	
		4	WP6412	
		5	WP6512	
		6	WP6612	
		6	WP8612	
		6	WP10612	
3Ø 4W 120/208 Volt 5 JAW 3-PHASE IN 1-PHASE OUT	200	2		WP4212J
		3		WP4312J
		4		WP4412J
		4		WP6412J
		5		WP6512J
		6		WP6612J
		6		WP8612J
		6	WP10612J	

NOTES:

1. Fault Rating is determined by circuit breaker rating. Circuit breakers are ordered separately.
2. Consult manufacturer for information regarding fault current ratings.
3. Follow manufacturer's instruction for assembly.
4. Mounting height must conform to DTE Requirements. (See page 5-3-11)
5. Ring Style Meter Socket Covers. Order SCREW-TYPE sealing rings.
6. NEMA type 3R construction

SIEMENS – ITE MODULES
ACCEPTABLE FOR DTE METERING

DIMENSIONS ARE AVAILABLE FOR PLANNING THROUGH MANUFACTURER'S CATALOG

THREE PHASE METER MODULES

SERVICE TYPE	METER SOCKET AMPERE RATING	VERTICAL METER POSITIONS	CATALOG NUMBERS
			THREE PHASE INDOOR/OUTDOOR
3Ø 4W 120/208, 120/240 Volt 7 JAW 3 POLE BRANCH <u>(3 PHASE METERING)</u>	225	1	WML13225RJ
		2	WML23225RJ
		3	WML33225RJ
		4	WML43225RJ
	100	1	WML13100RJ
		2	WML23100RJ
		3	WML33100RJ
		4	WML43100RJ
3-PHASE IN			
3-PHASE OUT			

- **NEMA type 3R construction**
- **Ringless type with lever bypass and jaw release**
- **200 Amp maximum Branch Main**

NOTES:

1. Fault Rating is determined by circuit breaker rating. Circuit breakers are ordered separately.
2. Consult manufacturer for information regarding fault current ratings.
3. Follow manufacturer's instruction for assembly.
4. Mounting height must conform to DTE Requirements. (See page 5-3-11)
5. Ringless Style Meter Socket Covers.

JUL 2024

TALON
ACCEPTABLE FOR DTE METERING

DIMENSIONS ARE AVAILABLE FOR PLANNING THROUGH MANUFACTURER'S CATALOG

METER UNI-PAKS

SERVICE TYPE	METER SOCKET AMPERE RATING	VERTICAL METER POSITIONS	CATALOG NUMBERS	
			SINGLE PHASE	OUTDOOR THREE PHASE
1Ø 3W 120/240 Volt 4 JAW	125	2	WTG2211	
		3	WTG3311	
		4	WTG4411	
		5	WTG4511	
		6	WTG4611	
		4	WTG6411	
		5	WTG6511	
		6	WTG6611	
3Ø 4W 120/208 Volt 5 JAW* 3-PHASE IN 1-PHASE OUT	125	2		WTG2211*
		3		WTG3311*
		4		WTG4411*
		5		WTG4511*
		6		WTG4611*
		4		WTG6411*
		5		WTG6511*
		6	WTG6611*	
1Ø 3W 120/240 Volt 4 JAW	200	2	WTG4212	
		3	WTG4312	
		4	WTG4412	
		4	WTG6412	
		5	WTG6512	
		6	WTG6612	
		6	WTG8612	
		6	WTG10612	
3Ø 4W 120/208 Volt 5 JAW* 3-PHASE IN 1-PHASE OUT	200	2		WTG4212*
		3		WTG4312*
		4		WTG4412*
		4		WTG6412*
		5		WTG6512*
		6		WTG6612*
		6		WTG8612*
		6	WTG10612*	

NOTES:

1. Fault Rating is determined by circuit breaker rating. Circuit breakers are ordered separately.
2. Consult manufacturer for information regarding fault current ratings.
3. Follow manufacturer's instruction for assembly.
4. Mounting height must conform to DTE Requirements. (See page 5-3-11)
5. Ring Style Meter Socket Covers. Order SCREW-TYPE sealing rings.
6. * - Required 5th Jaw Kit, order Cat # ECMF5 (un-insulated) or ECMF5i (insulated).
7. NEMA type 3R construction

SQUARE D MULTIPLE METERING EQUIPMENT
ACCEPTABLE FOR DTE METERING

DIMENSIONS ARE AVAILABLE FOR PLANNING THROUGH MANUFACTURER'S CATALOG

METER PAKS

SERVICE TYPE	METER SOCKET AMPERE RATING	VERTICAL METER POSITIONS	CATALOG NUMBERS	
			SINGLE PHASE	OUTDOOR THREE PHASE
1Ø 3W 120/240 Volt 4 JAW	125	2	EZM112125	⑤
		3	EZM113125	⑤
		4	EZM114125	⑤
		5	EZM115125	⑤
		6	EZM116125	⑤
3Ø 4W 120/208 Volt 5 JAW 3-PHASE IN 1-PHASE OUT	125	2		EZM312125 ⑤
		3		EZM313125 ⑤
		4		EZM314125 ⑤
		5		EZM315125 ⑤
		6		EZM316125 ⑤
1Ø 3W 120/240 Volt 4 JAW	225	2	EZM112225	⑤
		3	EZM113225	⑤
		4	EZM114225	⑤
		5	EZM115225	⑤
3Ø 4W 120/208 Volt 5 JAW 3-PHASE IN 1-PHASE OUT	225	2		EZM312225 ⑤
		3		EZM313225 ⑤
		4		EZM314225 ⑤
		5		EZM315225 ⑤

SQUARE D MULTIPLE METERING EQUIPMENT
ACCEPTABLE FOR DEC_o. METERING

3Ø 4W 120/208 Volt 120/240 Volt 7 JAW 3-PHASE IN 3-PHASE OUT	225	2		EZML332225 ⑥
		3		EZML333225 ⑥
		4		EZML334225 ⑥
				<ul style="list-style-type: none"> • NEMA type 3R construction • Ringless type with lever bypass and jaw release • 200 Amp maximum Branch Main

NOTES:

1. Fault Rating is determined by circuit breaker rating. Circuit breakers are ordered separately.
2. Consult manufacturer for information regarding fault current ratings.
3. Follow manufacturer's instruction for assembly.
4. Mounting height must conform to DTE Requirements. (See page 5-3-11)
- ⑤ Ring Style Meter Socket Covers. Order SCREW-TYPE sealing rings.
- ⑥ Ringless type with lever bypass and jaw release.

JUL 2024

SQUARE D MULTIPLE METERING EQUIPMENT
ACCEPTABLE FOR DTE METERING

DIMENSIONS ARE AVAILABLE FOR PLANNING THROUGH MANUFACTURER'S CATALOG

EZ METER PAKS

SERVICE TYPE	METER SOCKET AMPERE RATING	MAIN AMPERE RATING	VERTICAL METER POSITIONS	CATALOG NUMBERS INDOOR/OUTDOOR
1Ø 3W 120/240 Volt 4 JAW	125	200	2	MP22125
		300	3	MP33125
		400	4	MP44125
		500	5	MP55125
		600	6	MP66125
1Ø 3W 120/240 Volt 4 JAW	200	400	2	MP42200
		400	3	MP43200
		600	4	MP64200
		800	5	MP85200
		800	6	MP86200

NOTES:

1. Fault Rating is determined by circuit breaker rating. Circuit breakers are ordered separately.
2. Consult manufacturer for information regarding fault current ratings.
3. Follow manufacturer's instruction for assembly.
4. Mounting height must conform to DTE Requirements. (See page 5-3-11)
5. Ring Style Meter Socket Covers. Order SCREW-TYPE sealing rings.
6. NEMA type 3R construction.

SQUARE D MULTIPLE METERING EQUIPMENT
ACCEPTABLE FOR DTE METERING

DIMENSIONS ARE AVAILABLE FOR PLANNING THROUGH MANUFACTURER'S CATALOG

Main Breaker

DEVICE AMPERE RATING	SINGLE PHASE OUTDOOR	THREE PHASE OUTDOOR
400	EZM1400CB	EZM3400CB
600	EZM1600CB	EZM3600CB
800	EZM1800CB	EZM3800CB
1000	EZM11000CB	EZM31000CB
1200	EZM11200CB	EZM31200CB
1600	EZM11600CB	EZM31600CB

Tap Box

DEVICE AMPERE RATING	SINGLE PHASE OUTDOOR	THREE PHASE OUTDOOR
400	EZM1400TB	EZM3400TB
600	EZM1600TB	EZM3600TB
800	EZM1800TB	EZM3800TB
1600	EZM11600TB	EZM31600TB

Fusible Switch

DEVICE AMPERE RATING	SINGLE PHASE OUTDOOR	THREE PHASE OUTDOOR
400	EZM1400FS	EZM3400FS
600	EZM1600FS	EZM3600FS
800	EZM1800FS	EZM3800FS
1200	EZM11200FS	-----

NOTES:

1. Consult manufacturer for information regarding fault current rating.
2. Follow the manufacturer's instruction for assembly.
3. Mounting heights must conform to DTE requirements. (See page 5-3-11)
4. On 120/208 Volt service, see meter stack table for proper equipment order.
5. NEMA type 3R construction.

JUL 2024

MURRAY (SIEMENS) ELECTRICAL PRODUCTS
ACCEPTABLE FOR DTE ELECTRIC METERING

DIMENSIONS ARE AVAILABLE FOR PLANNING THROUGH MANUFACTURER'S CATALOG

METER UNI-PAKS

SERVICE TYPE	METER SOCKET AMPERE RATING	VERTICAL METER POSITIONS	CATALOG NUMBERS OUTDOOR SINGLE PHASE
1Ø 3W 120/240 Volt 4 JAW	125	2	MP2211
		3	MP3311
		4	MP4411
		5	MP4511
		6	MP4611
		5	MP6511
		6	MP6611
1Ø 3W 120/240 Volt 4 JAW	200	2	MP4212
		3	MP4312
		4	MP4412
		4	MP6412
		5	MP6512
		6	MP6612

NOTES:

1. Fault Rating is determined by circuit breaker rating. Circuit breakers are ordered separately.
2. Consult manufacturer for information regarding fault current ratings.
3. Follow manufacturer's instruction for assembly.
4. Mounting height must conform to DTE Requirements. (See page 5-3-11)
5. Ring Style Meter Socket Covers. Order SCREW-TYPE sealing rings.
6. Ringless and 5th Jaw included enclosure order; add RJ in catalog number as WPxxxxRJ.
7. NEMA type 3R construction.

**MURRAY ELECTRICAL PRODUCTS
ACCEPTABLE FOR DTE METERING**

DIMENSIONS ARE AVAILABLE FOR PLANNING THROUGH MANUFACTURER'S CATALOG

Circuit Breaker Module^①

AMPERES	SINGLE PHASE OUTDOOR	THREE PHASE OUTDOOR
400	DB042W	DB043W
600	DB062W	DB063W
800	DB082W	DB083W
1000	DB102W	DB103W
1200	DB122W	DB123W
1600	n/a	DB163W

Tap Box Module^②

AMPERES	SINGLE PHASE OUTDOOR	THREE PHASE OUTDOOR
800	DTB082W	DTB083W
1200	DTB122W	DTB123W
1600	DTB163W	

Fusible Switch Module^②

AMPERES	SINGLE PHASE OUTDOOR	THREE PHASE OUTDOOR
400	DT042W	DT043W
600	DT062W	DT063W
800	DT082W	DT083W

①Units are designed for top feed. Consult manufacturer if bottom fed installation.

②Units are top feed, invertible for bottom feed. (See manufacturer catalog for instructions).

③NEMA type 3R construction.

JUL 2024

GENERAL ELECTRIC (G.E.) FOR MULTIPLE METERING EQUIPMENT
ACCEPTABLE FOR DTE METERING

DIMENSIONS ARE AVAILABLE FOR PLANNING THROUGH MANUFACTURER'S CATALOG

METER MOD III MODULAR METERING – MAIN MODULES

Main Breaker Modules (Top or Bottom Feed)

DEVICE AMPERE RATING	SINGLE PHASE INDOOR/OUTDOOR	THREE PHASE INDOOR/OUTDOOR
400 (42,000)	TMPSB4R	TMP3SB4R
400 (100,000)	TMPSHB4R	TMP3SHB4R
600 (42,000)	TMPSB6R	TMP3SB6R
600 (100,000)	TMPSHB6R	TMP3SHB6R
800 (65,000)	TMPSB8R	TMP3SB8R
1000 (65,000)	TMPSB10R	TMP3SB10R
1200 (65,000)	TMPSB12R	TMP3SB12R

Main Switch Modules (T-Fuses Not Included)

DEVICE AMPERE RATING	FEED	SINGLE PHASE INDOOR/OUTDOOR	THREE PHASE INDOOR/OUTDOOR
400	TOP	TMPFT4R	TMP3FT4R
400	BOTTOM	TMPFB4R	TMP3FB4R
600	TOP	TMPFT6R	TMP3FT6R
600	BOTTOM	TMPFB6R	TMP3FB6R
800	TOP	TMPFT8R	TMP3FT8R
800	BOTTOM	TMPFB8R	TMP3FB8R

Main Lug Modules (Top or Bottom Feed)

DEVICE AMPERE RATING	SINGLE PHASE INDOOR/OUTDOOR	THREE PHASE INDOOR/OUTDOOR
400	Use 3-PHASE	TMP3L4R
600	Use 3-PHASE	TMP3L6R
800	TMPL8R	TMP3L8R
1200	TMPL12R	TMP3L12R

NOTES:

1. Consult manufacturer for information regarding fault current rating.
2. Follow the manufacturer's instruction for assembly.
3. Mounting heights must conform to DTE requirements. (See page 5-3-11)
4. On 120/208 Volt service, balance phase loading by selecting proper phase connectors.
5. NEMA type 3R construction.

JAN 2025

ABB FOR MULTIPLE METERING EQUIPMENT
ACCEPTABLE FOR DTE METERING

DIMENSIONS ARE AVAILABLE FOR PLANNING THROUGH MANUFACTURER'S CATALOG

ReliaMod MODULAR METERING – MAIN MODULES

<u>Main Breaker Modules</u>			
DEVICE AMPERE RATING	FEED # OF LUGS	SINGLE PHASE INDOOR/OUTDOOR	THREE PHASE INDOOR/OUTDOOR
400 (65,000)	TOP/BOTTOM	RMM1BL4R	RMM3BL4R
400 (100,000)	TOP/BOTTOM	RMM1BH4R	RMM3BH4R
600 (65,000)	TOP/BOTTOM	RMM1BL6R	RMM3BL6R
600 (100,000)	TOP/BOTTOM	RMM1BH6R	RMM3BH6R
800 (65,000)	TOP/BOTTOM	RMM1BL8R	RMM3BL8R
800 (100,000)	TOP/BOTTOM	RMM1BH8R	RMM3BH8R
1000 (65,000)	TOP/BOTTOM	RMM1BL10R	RMM3BL10R
1000 (100,000)	TOP/BOTTOM	RMM1BH10R	RMM3BH10R
1200 (65,000)	TOP/BOTTOM	RMM1BL12R	RMM3BL12R
1200 (100,000)	TOP/BOTTOM	RMM1BH12R	RMM3BH12R
1600 (100,000)	BOTTOM (6)	RMM1BB16RL	RMM3BB16RL
2000 (100,000)	BOTTOM (6)	RMM1BB20RL	RMM3BB20RL

Main Switch Modules (T-Fuses Not Included) – Top or Bottom Feed

DEVICE AMPERE RATING	SINGLE PHASE INDOOR/OUTDOOR	THREE PHASE INDOOR/OUTDOOR
400	RMM1F4R	RMM3F4R
600	RMM1F6R	RMM3F6R
800	RMM1F8R	RMM3F8R

Main Lug Modules - Top or Bottom Feed

DEVICE AMPERE RATING	SINGLE PHASE INDOOR/OUTDOOR	THREE PHASE INDOOR/OUTDOOR
400	RMM1L4R	RMM3L4R
600	RMM1L6R	RMM3L6R
800	RMM1L8R	RMM3L8R
1200	RMM1L12R	RMM3L12R
1600	RMM1L16R	RMM3L16R

NOTES:

1. Consult manufacturer for information regarding fault current rating.
2. Follow the manufacturer's instruction for assembly.
3. Mounting heights must conform to DTE requirements. (See page 5-3-11)
4. On 120/208 Volt service, balance phase loading by selecting proper phase connectors.
5. NEMA type 3R construction.

ABB MULTIPLE METERING EQUIPMENT
ACCEPTABLE FOR DTE METERING

DIMENSIONS ARE AVAILABLE FOR PLANNING THROUGH MANUFACTURER'S CATALOG

METER MODULES – SINGLE PHASE

SERVICE TYPE	MAIN	METER SOCKET	VERTICAL	CATALOG NUMBERS	
		AMPERE RATING	METER POSITIONS	SINGLE PHASE IN	THREE PHASE IN
1Ø 3W 120/240V 4 JAW and 3Ø 4W* 120/208V* 5 JAW*	800	125 (22,000)	2	RMS18212LRLR*	RMS28212LRLR*
			3	RMS18312LRLR*	RMS28312LRLR*
			4	RMS18412LRLR*	RMS28412LRLR*
			5	RMS18512LRLR*	RMS28512LRLR*
			6	RMS18612LRLR*	RMS28612LRLR*
			2	RMS18212HRLR*	RMS28212HRLR*
	800	225 (100,000)	3	RMS18312HRLR*	RMS28312HRLR*
			4	RMS18412HRLR*	RMS28412HRLR*
			5	RMS18512HRLR*	RMS28512HRLR*
			6	RMS18612HRLR*	RMS28612HRLR*
			2	RMS18222LRLR*	RMS28222LRLR*
			3	RMS18322LRLR*	RMS28322LRLR*
800	225 (100,000)	4	RMS18422LRLR*	RMS28422LRLR*	
		5	RMS18522LRLR*	RMS28522LRLR*	
		2	RMS18222HRLR*	RMS28222HRLR*	
		3	RMS18322HRLR*	RMS28322HRLR*	
		4	RMS18422HRLR*	RMS28422HRLR*	
		5	RMS18522HRLR*	RMS28522HRLR*	
1200	125 (22,000)	2	RMS112212LRLR*	RMS212212LRLR*	
		3	RMS112312LRLR*	RMS212312LRLR*	
		4	RMS112412LRLR*	RMS212412LRLR*	
		5	RMS112512LRLR*	RMS212512LRLR*	
		6	RMS112612LRLR*	RMS212612LRLR*	
		2	RMS112212HRLR*	RMS212212HRLR*	
1200	125 (100,000)	3	RMS112312HRLR*	RMS212312HRLR*	
		4	RMS112412HRLR*	RMS212412HRLR*	
		5	RMS112512HRLR*	RMS212512HRLR*	
		6	RMS112612HRLR*	RMS212612HRLR*	

*REQUIRED 5TH JAW KIT = RM5THJAWISO

NOTES:

1. Fault Rating is determined by circuit breaker rating. Circuit breakers are ordered separately.
2. Consult manufacturer for information regarding fault current ratings.
3. Follow manufacturer's instruction for assembly.
4. Mounting height must conform to DTE Requirements. (See page 5-3-11)
5. On 120/208 Volt service, balance phase loading by selecting proper phase connectors.
6. NEMA type 3R construction.

ABB MULTIPLE METERING EQUIPMENT
ACCEPTABLE FOR DTE METERING

DIMENSIONS ARE AVAILABLE FOR PLANNING THROUGH MANUFACTURER'S CATALOG

METER MODULES – SINGLE PHASE

SERVICE TYPE	MAIN	METER SOCKET AMPERE RATING	VERTICAL METER POSITIONS	CATALOG NUMBERS OUTDOORS	
				SINGLE PHASE IN	THREE PHASE IN
1Ø 3W	1200	225 (22,000)	2	RMS112222LRLR*	RMS212222LRLR*
120/240V			3	RMS112322LRLR*	RMS212322LRLR*
4 JAW			4	RMS112422LRLR*	RMS212422LRLR*
and			5	RMS112522LRLR*	RMS212522LRLR*
3Ø 4W*	1200	225 (100,000)	2	RMS112222HRLR*	RMS212222HRLR*
120/208V*			3	RMS112322HRLR*	RMS212322HRLR*
5 JAW*			4	RMS112422HRLR*	RMS212422HRLR*
			5	RMS112522HRLR*	RMS212522HRLR*

*REQUIRED 5TH JAW KIT = RM5THJAWISO

METER MODULES – THREE PHASE – LEVER BYPASS

SERVICE TYPE	MAIN	METER SOCKET AMPERE RATING	VERTICAL METER POSITIONS	CATALOG NUMBERS
				OUTDOORS
3Ø 4W	1200	225	1	RMS312122CHLBR
120/208V			2	RMS312222CHLBR
120/240V			3	RMS312322CHLBR
7 JAW			4	RMS312422CHLBR
3 POLE BRANCH 120/208V*				

NOTES:

1. Fault Rating is determined by circuit breaker rating. Circuit breakers are ordered separately.
2. Consult manufacturer for information regarding fault current ratings.
3. Follow manufacturer's instruction for assembly.
4. Mounting height must conform to DTE Requirements. (See page 5-3-11)
5. On 120/208 Volt service, balance phase loading by selecting proper phase connectors.
6. NEMA type 3R construction.

ELECTRIC METER ENCLOSURES AND ACCESSORIES
APPROVED FOR USE IN THE DTE ELECTRIC SERVICE TERRITORY

All products must be UL labeled.

Enclosure Type	Manufacturer	Catalog No	Amps	Service Type	Discontinued on
<i>1 Phase, Ringless, 4 Terminals, 240V</i>					
Single Meter	Cooper B-line	EN12L43GRID (Note 8)	125	UG	
Single Meter	Eaton	1006385B-CH (Note 8)	125	UG	
Single Meter	Durham	1006385B (Note 8)	125	UG	
Single Meter	Talon	UAT111-XGF (Note 8)	125	UG	
Single Meter	Midwest Electric Products	1006385B-MEP (Note 8)	125	UG	
Single Meter	Milbank	U7487-O-TG (Note 8)	125	UG	
Single Meter	Siemens	UAT111-XGF (Note 8)	125	UG	
Single Meter	Square D	1006385B-SQD (Note 8)	125	UG	
Single Meter	Cooper B-line	EN20L41GRID	200	OH	
Single Meter	Eaton	1004709D-CH	200	OH	
Single Meter	Durham	1004709D	200	OH	
Single Meter	Talon	UAT317-0GF (Note 2)	200	OH	
Single Meter	Siemens	UAT317-0GF (Note 2)	200	OH	
Single Meter	Midwest Electric Products	1004709D-MEP	200	OH	
Single Meter	Milbank	U7021-RL-TG (Note 1)	200	OH	
Single Meter	Square D	1004709D-SQD	200	OH	
Single Meter	Cooper B-line	EN20L43GRID	200	OH/UG	
Single Meter	Eaton	UTRS213BE (AE or CE) (Note 1) (Note7)	200	OH/UG	
Single Meter	Durham	1004710E (Note 3)	200	OH/UG	
Single Meter	Talon	UAT417-XGF	200	OH/UG	
Single Meter	Siemens	UAT417-XGF	200	OH/UG	
Single Meter	Midwest Electric Products	1004710E-MEP (Note 3)	200	OH/UG	
Single Meter	Milbank	U7040-RL-TG (Note 1)	200	OH/UG	
Single Meter	Square D	1004710E-SQD (Note 3)	200	OH/UG	

Discontinued Equipment, To Use Until Stock Is Depleted:

None

SERVICE EQUIPMENT

5-8-14

JUL 2024

Enclosure Type	Manufacturer	Catalog No	Amps	Service Type	Discontinued on
1 Phase, Ringless, 4 Terminals, 240V, With Lever Bypass and Jaw Release					
Single Meter	Eaton	1009788EA-CH (Note 3) (Note 6)	320	OH/UG	
Single Meter	Durham	1009788A (Note 3)	320	OH/UG	
Single Meter	Talon	48504-846	320	UG	
Single Meter	Midwest Electric Products	1009788A-MEP (Note 3)	320	OH/UG	
Single Meter	Milbank	U1129-O-DTE	320	UG	
Single Meter	Siemens	S48504-846	320	UG	
Single Meter	Square D	1009788A-SQD (Note 3)	320	OH/UG	

Discontinued Equipment, To Use Until Stock Is Depleted:

None

SERVICE EQUIPMENT

5-8-15

JUL 2024

Enclosure Type	Manufacturer	Catalog No	Amps	Service Type	Discontinued on
<i>1 Phase, Ringless, 4 Terminals, 480V, With Lever Bypass and Jaw Release</i>					
Single Meter	Cooper B-line	EL20L43GRST	200	OH/UG	
Single Meter	Eaton	1009995E-CH (Note 3)	200	OH/UG	
Single Meter	Durham	1009995 (Note 3)	200	OH/UG	
Single Meter	Talon	40404-02QG	200	OH/UG	
Single Meter	Midwest Electric Products	1009995-MEP (Note 3)	200	OH/UG	
Single Meter	Milbank	U9801-RXL	200	OH/UG	
Single Meter	Siemens	S40404-02QG	200	OH/UG	
Single Meter	Square D	1009995-SQD (Note 3)	200	OH/UG	

Discontinued Equipment, To Use Until Stock Is Depleted:

None

3 Phase, Ringless, Self-Contained, 7 Terminals, 480V, With Lever Bypass and Jaw Release

Single Meter	Cooper B-line	EL20L73GRST	200	OH/UG	
Single Meter	Eaton	U-E7213C-CH (Note 3) (Note 4)	200	OH/UG	
Single Meter	Durham	U-H7213C (Note 3) (Note 4)	200	OH/UG	
Single Meter	Talon	40407-025	200	OH/UG	
Single Meter	Midwest Electric Products	U-H7213C-MEP (Note 3) (Note 4)	200	OH/UG	
Single Meter	Milbank	U9701-RXL	200	OH/UG	
Single Meter	Siemens	S0407-025	200	OH/UG	
Single Meter	Square D	U-H7213C-SQD (Note 3) (Note 4)	200	OH/UG	

Discontinued Equipment, To Use Until Stock Is Depleted:

None

3 Phase 3Wire, Ringless, Self-Contained, 5 Terminals, 120-480V, With Lever Bypass and Jaw Release

Single Meter	Milbank	U9551-RXL	200	OH/UG	
--------------	---------	-----------	-----	-------	--

SERVICE EQUIPMENT

5-8-16

JUL 2024

Enclosure Type	Manufacturer	Catalog No	Amps	Service Type	Discontinued on
<i>3 Phase 4Wire, Ringless, 120-480V, CT Rated with Test Switch wired per DTE specifications.</i>					
Single Meter	Eaton	1007003C-CH		20	4 wire
Single Meter	Durham	1007003C		20	4 wire
Single Meter	Talon	9837-0907		20	4 wire
Single Meter	Meter Devices	602-3010A13-588		20	4 wire
Single Meter	Meter Devices	606-8015A-4 (Note 5) (Meter Enclosure only)		20	4 wire/ 3 wire
Single Meter	Meter Devices	607-8024A13-999 (Note 5) (pre-wired meter panel)		20	4 wire
Single Meter	Midwest Electric Products	1007003C-MEP		20	4 wire
Single Meter	Milbank	UC6473-O-21		20	4 wire
Single Meter	Square D	1007003C-SQD		20	4 wire
<i>Discontinued Equipment, To Use Until Stock Is Depleted:</i>					
Single Meter	Milbank	UC7445-O-521		20	4 wire 3/31/2019
<i>1 or 3 Phase 3 Wire, Ringless, 120-480V, CT Rated with Test Switch wired per DTE specifications</i>					
Single Meter	Eaton	1007361C-CH		20	3 wire
Single Meter	Durham	1007361C		20	3 wire
Single Meter	Talon	9837-0908		20	3 wire
Single Meter	Meter Devices	602-3010A8-589		20	3 wire
Single Meter	Meter Devices	607-8024A8-1000 (Note 5) (pre-wired meter panel)		20	3 wire
Single Meter	Midwest Electric Products	1007361C-MEP		20	3 wire
Single Meter	Milbank	UC6472-O-21		20	3 wire
Single Meter	Square D	1007361C-SQD		20	3 wire
<i>Discontinued Equipment, To Use Until Stock Is Depleted:</i>					
Single Meter	Milbank	UC7444-O-201		20	3 wire 3/31/2019

Enclosure Type	Manufacturer	Catalog No	Amps	Service Type	Discontinued on
<i>Auxiliary Contacts Enclosure (AC-10)</i>					
Aux. Contacts	Cooper B-line	644 RTSC	-	-	
Aux. Contacts	Eaton	1006630A-CH	-	-	
Aux. Contacts	Durham	1006630A	-	-	
Aux. Contacts	Midwest Electric Products	1006630A-MEP	-	-	
Aux. Contacts	Square D	1006630A-SQD	-	-	
<i>1 Phase, Ringless, 4 Terminals, 240V</i>					
2 Position Horizontal	Cooper B-line	HEN20432CGRST	200	UG	
2 Position Horizontal	Eaton	1006737B-CH	200	UG	
2 Position Horizontal	Durham	1006737B	200	OH/UG	
2 Position Horizontal	Talon	UA2716-XG	200	OH/UG	
2 Position Horizontal	Midwest Electric Products	1006737B-MEP	200	UG	
2 Position Horizontal	Milbank	U1252-X	200	OH/UG	
2 Position Horizontal	Siemens	SUA2716-XG	200	OH/UG	
2 Position Horizontal	Square D	1006737B-SQD	200	UG	

NOTES:

1. For some enclosures the hub, top closing plate, or lugs must be ordered separately.
2. For all 5 Terminals, 208V service installations, order the conversion kit separately and install the 5th terminal in 9 o'clock position.
3. Unit supplied with hub cover plate. If hub is required order separately per Kit # listed on the interior label.
4. A "UT" prefix is acceptable (UT-H7213C) but the smaller grounding terminal shall not be used.
5. Order one Meter Enclosure and one Pre-wired Meter Panel for a complete set.
6. Unit supplied with Durham auxiliary line bus conversion kit #ARP01613-CH.
7. For all 5 Terminals, 208V service installations, order the conversion kit #MSR5KT separately and install the 5th terminal in 9 o'clock position.
8. Only for water heater, air conditioner, and special applications approved by Service Planning.

ELECTRIC METER ENCLOSURES AND ACCESSORIES
 APPROVED FOR USE IN THE DTE ELECTRIC SERVICE TERRITORY

All products must be UL labeled.

Enclosure Type	Manufacturer	Catalog No	Amps	Service Type	Discontinued on
<i>1 Phase, Ringless, 4 Terminals, 240V With Disconnect</i>					
Single Meter	Milbank	U5168-XL-200	200	OH/UG	
Single Meter	Milbank	U5268-XTL-200	200	OH/UG	
<i>1 Phase, Ringless, 4 Terminals, 240V, With Disconnect, Lever Bypass and Jaw Release</i>					
Single Meter	Milbank	U6585-X-2-200-K3L	320	OH/UG	
<i>1 Phase, Ringless, 4 Terminals, 240V With Disconnect</i>					
2 Position Horizontal	Milbank	U5822-X (2 pos)	200	OH/UG	

NOTES:

1. For some enclosures the hub, top closing plate, or lugs must be ordered separately.
2. For all 5 Terminals, 208V service installations, order the conversion kit separately and install the 5th terminal in 9 o'clock position.

CURRENT AVAILABLE TO A FAULT

1. DTE personnel no longer calculate customers secondary fault currents. It is the responsibility of the Electrical contractor, architect, consulting engineer or the local electrical inspector for new installations and those who make changes to the original electrical design, resulting in a change of service conductor size and/or transformer size for proper secondary fault current calculations.
2. Residential single occupancy home services will supply 10,000 amperes or less to a fault and, therefore, need not be calculated.
3. The person responsible for the service entrance design and installation may use the calculated value to comply with 2023 NEC 110.9; *Interrupting Rating*, 110.10; *Circuit Impedance, Short-Circuit Ratings, and Other Characteristics*, and 230.95; *Ground-Fault Protection of Equipment*.
4. DTE personnel will not advise on service entrance equipment or design requirements for the available fault current.
5. Requests by the Electrical contractor, architect, consulting engineer or the local electrical inspector should be submitted to a service Planner for new or existing transformer size/type for their calculation of secondary fault current with the proper impedances.

SERVICE PLANNER:

Will advise customers of the DTE Energy informational websites for proper Transformer Impedances and other related topics.

Information about electric service including Transformer Impedances for DTE's power distribution transformers necessary for calculating available fault current is available on the DTE Energy website www.dteenergy.com , under Business, Builders/Contractors, Electric Service, and Service Information.

**Section 5 ESIG
Sequence List**

Page	Year	Revision Description
05-01-01	Aug-23	Item (j) was added to make clear that no customer owned equipment is to be located within the DTE sealed sections of service equipment.
05-01-02	Aug-23	Language was shifted to proceeding the pages to accommodate the change in 5-1-1
05-01-03	Aug-23	Language was shifted to proceeding the pages to accommodate the change in 5-1-1
05-01-04	Aug-23	Language was shifted to proceeding the pages to accommodate the change in 5-1-1
05-01-05	Oct-06	
05-01-07	Jan-22	Diagram was updated to include foundation grounding per NEC 2017 250.52(A)(3)
05-01-08	Jan-22	"Bonding for Other systems" changed to "Bonding for Communication systems" to match current language of the NEC
05-01-09	Oct-06	
05-01-10	Oct-06	
05-02-01	Aug-21	Updated text with current callout and contact info
05-03-01	Oct-06	
05-03-02	Oct-17	Added NEC meter box note
05-03-03	Feb-23	Separated Single phase specs into 240V and 120/208V, removed amperage derating
05-03-04	Aug-18	Clarified max load amperes
05-03-05	Feb-16	Removed reference to CL 100 meter box
05-03-06	Dec-21	Cleaned up formatting
05-03-07	Aug-18	Changed max demand load to 320 A in note 7
05-03-7.1	Oct-17	Added NEC meter box note
05-03-7.2	Oct-17	Added NEC meter box note
05-03-08	Oct-17	Added NEC meter box note
05-03-8.1	Oct-17	Added NEC meter box note
05-03-8.2	May-22	Created new single phase checklist
05-03-8.3	May-22	Created new single phase checklist
05-03-8.4	May-22	Created new single phase checklist
05-03-11	Aug-19	Added 6 meter high option
05-03-12	Nov-20	New spec
05-03-14	Oct-17	Added NEC meter box note
05-03-15	Oct-17	Added NEC meter box note
05-03-16	Dec-06	
05-03-17	Oct-17	Added NEC meter box note
05-03-18	Oct-17	Added NEC meter box note
05-03-19	Oct-17	Added NEC meter box note
05-03-19.1	Feb-18	Specified entrance of metal conduit into meter socket, note 1
05-03-19.2	Aug-01	
05-03-20	Dec-06	
05-03-21	Dec-06	
05-03-22	Oct-17	Added NEC meter box note
05-03-23	Sep-04	
05-03-24	Sep-04	
05-03-25	Sep-04	
05-03-26	Nov-20	Clarified number of conductors per conduit
05-03-27	Nov-20	Clarified number of conductors per conduit

**Section 5 ESIG
Sequence List**

05-04-01	Oct-19	Updated 3. Building Owner Responsibilities
05-04-02	Nov-09	
05-04-03	Nov-09	
05-04-04	Nov-09	
05-04-05	Jun-06	
05-04-06	Nov-09	
05-04-07	Aug-20	Added minor detail regarding the Meter enclosure to CT cab conduit attachment location
05-04-08	Aug-20	Added minor detail regarding the Meter enclosure to CT cab conduit attachment location
05-04-09	Oct-17	Added NEC meter box note
05-04-10	Oct-06	
05-04-11	Dec-90	
05-04-12	Aug-18	Corrected meter conduit locations
05-04-13	Mar-95	
05-04-14	Oct-06	Added "(line)" after "service" on bottom drawing
05-04-15	Nov-20	Clarified number of conductors per conduit
05-04-16	Nov-22	Revised line 18 of checklist
05-04-17	Nov-20	Clarified number of conductors per conduit
05-04-18	Nov-20	Clarified number of conductors per conduit
05-04-19	Nov-19	Removed form 5S option from 1.
05-04-20	Oct-17	Added NEC meter box note
05-05-01	Jan-08	
05-05-03	Jan-08	
05-06-01	Aug-21	Updated text, NEC, and ANSI callouts
05-06-1.1	Aug-21	Updated text for better flow
05-06-02	Aug-21	Updated text
05-06-2.1	Aug-21	
05-06-03	Aug-21	Added NEC meter box note
05-06-04	Aug-21	Changed callout to require use of PVC
05-06-05	Aug-21	Added NEC callout in diagram regarding min height restrictions
05-06-06	Aug-21	Updated title
05-06-07	Aug-21	
05-06-08	Aug-21	
05-06-09	Aug-21	
05-06-10	Aug-21	Added note about sealing hasp for top of door
05-06-11	Aug-21	Updated NEC and ANSI callouts. Modified text for better flow
05-06-12	Aug-21	Updated text
05-06-13	Aug-21	Clarified number of conductors per conduit
05-06-14	Aug-22	Revised line 15 of checklist
05-06-15	Aug-21	Modified line 36 to require use of PVC when passing through switchboard
05-07-01	Oct-06	
05-07-02	Oct-06	
05-07-04	Dec-90	
05-07-05	Mar-95	
05-08-01	Feb-23	Vendor revision, 1MCB and 3MCB prefixes were replaced with 1PMB and 3PMB
05-08-02	Oct-19	Aug: Added 3ph 200A 5 position module. Oct: Added 1ph 200A 5 position module
05-08-03	Jan-17	Cutler-Hammer changed to Eaton
05-08-3.1	Feb-08	

**Section 5 ESIG
Sequence List**

05-08-04	Jul-18	Added 1200 Amp Fusible Switch 1ph and 3ph, added note 2
05-08-05	Jun-09	
05-08-5.1	Jun-09	
05-08-06	Nov-17	Added three phase columns
05-08-6.1	Jun-09	
05-08-6.2	Mar-19	New spec
05-08-07	Feb-08	
05-08-08	Feb-08	
05-08-09	Feb-08	
05-08-10	Apr-17	Added note 6
05-08-10.1	Feb-08	
05-08-11	Feb-08	
05-08-12	Feb-08	
05-08-13	Nov-17	Revised some Siemens and Talon equipment information
05-08-14	Jul-18	Added discontinued equipment
05-08-15	Jul-18	Added discontinued equipment
05-08-16	Apr-19	Updated Milbank CT enclosure catalog information
05-08-17	Nov-17	Revised some Siemens and Talon equipment information
05-09-01	Jun-14	
05-08-12.1	Jan-25	New - ABB ReliaMod multiple metering equipment added to approved list
05-08-12.2	Jan-25	New - ABB ReliaMod multiple metering equipment added to approved list
05-08-12.3	Jan-25	New - ABB ReliaMod multiple metering equipment added to approved list
05-06-12	Jan-25	ABB added to approved list of switchboard manufacturers
05-08-13	Jan-25	Siemens and Talon part numbers updated to reflect manufacturer changes